

**THE
ENERGY MACHINE
OF
JOSEPH NEWMAN**

by
Joseph Westley Newman

An Invention Whose Time Has Come

Written and published by Joseph W. Newman
(Edited by Evan R. Soule, Jr.)
NEW ORLEANS, LOUISIANA

DEDICATED TO ALL THE PEOPLES OF THE
WORLD WHO LIVE AND ARE YET TO BE BORN

Preface

To you, the reader, I apologize in advance if I offend, by the manner in which I put forth my revolutionary Scientific Hypotheses relative to numerous, presently accepted scientific statements with which I scientifically disagree.

Please consider that during these last 19 years, I have taught myself physics, chemistry, electrical engineering, and astronomy. The result of my years of research (which proposes a Unified Field Theory concerning all physical phenomena) has been a continuing and expanding thesis that I have written in a manner to which the present scientific community is not accustomed.

If I am guilty of offending anyone due to my love of pure science (which truly exists without any intellectual or artificial boundaries of any type) — I sincerely apologize in advance to you.

However, it is my earnest belief that my method will serve a most beneficial improvement in the future development and progress of Science and the human species — which, if not in the present, will in the future be greatly appreciated by those who will follow after us and look to you and me for a smoother road through life.

Consider the fact, for example, that over thirty fundamental atomic particles have been released from the nucleus of an atom. And the more that is known, the more the mystery deepens. Physicists are no longer even certain that protons, neutrons, and electrons occupy space. Some hypotheses describe these particles as waves or points without volume — mathematical singularities which “haunt” space.

Based on the present scientific understanding of matter, this same description would apply to the energy in the force fields of a magnet.

However, it would appear that the nuclear and magnetic forces are electromagnetic energy and possess mechanical-like characteristics which can be predicted and explained. The proof of the truth of this statement lies within this Book which I have written following 19 years of work and research.

I open this scientific work with the same statement with which I end it — a note from my writings dated Friday, 9:00 p.m., April 19, 1968:

“To all people whose brain burns and aches to accomplish great things and changes for the good, may God and/or the Goodness of the Universe be with you. For you are the Goodness of the Universe and do good for the people in spite of themselves. And I salute you!”

—*Joseph Westley Newman, 1984*

AUTHOR'S NOTE

I urge the reader to read this Book in its entirety, in the sequence of its development and presentation. This Book is developed logically from one concept to the next — just as I originally innovated the concepts which led to the creation of my energy machine. By skipping through the Book, the reader runs the risk of not thoroughly mastering the Theory upon which rests the technological innovation. The specific innovation is, in fact, less important to me than a *proper comprehension* of the Theory itself.

I also wish to assure the reader that the Editor and I are aware of accepted grammatical customs. I choose to use certain grammatical variations for purposes of conceptual emphasis and to encourage the reader to study carefully what is presented.

In Chapter One, I utilize a quotation from James Clerk Maxwell regarding the mechanical nature of a magnetic field in which he said: “In speaking of the Energy of the field, however, I wish to be understood literally. All energy is the same as mechanical energy ...” Historically, as it turns out, Maxwell has *not* been taken literally. In fact, this statement by Maxwell has been *literally ignored* by those who followed him. Perhaps James Clerk Maxwell’s statement would not have been ignored or overlooked had he written the words **I WISH TO BE UNDERSTOOD LITERALLY** with greater stylistic emphasis.

By intentionally “breaking” the flow of information (to the reader) with the use of quotation marks and parentheses, I am stylistically encouraging the reader to proceed carefully and “Master” what I teach.

The term “Master” should connote to the reader the same meaning as the historical distinction between “Master” and “Apprentice.” Please understand that I do not intend the term to have a derogatory implication to the reader. This is simply my way of encouraging the reader to understand (carefully and systematically) — rather than only memorize — what is presented in this Book.

My unorthodox treatment of certain words and grammatical devices is intended to partially counter-balance the psychological effects of a teaching system which often rewards memorization and ignores or penalizes a sincere, questioning attitude.

I must stress that my purpose is not in any way to condemn or question the intellectual ability of the reader. My sincere purpose is to question and improve the operational nature of the educational system.

EDITOR'S NOTE:

Those who understand the essential nature of Mr. Newman's energy machine may claim that its design is "simple and obvious." Of course it is. All great concepts and many major inventions throughout our history are very "simple and obvious" — but only *after* they are understood. The wheel is "simple and obvious," but it is nevertheless a very important invention that revolutionized our development as a species. One might ask: "Why was the wheel not 'obvious' to the countless human beings who lived before the inventor of the wheel?" The following quotation* from Christian Morgenstern answers this question quite elegantly:

"The obvious is that which is never seen until someone expresses it simply."

*Evan Soule, Jr. wishes to express his gratitude to physicist Andrew J. Galambos for bringing to his attention the above quotation by Christian Morgenstern, and for sensitizing him to the nature of innovation via a proper perspective for that which is "obvious." Professor Galambos has actually re-stated Morgenstern's quotation: "*The obvious is that which is never understood until someone expresses it simply.*" [Professor Galambos was originally informed of the Morgenstern quotation by Mr. Jerome Smith.]

Acknowledgements

I wish to express my deepest thanks and love to my Dear Wife, Margaret Ellen Green Newman, who has always demonstrated unending patience and faith in me and in the importance of my work. She has always eagerly offered to help in any capacity whatsoever to see such work to its completion. She has always demonstrated a deep and understanding love for me in spite of my unbending determination to achieve the completion of my work above all else. She has been and is the perfect wife for me. Her beauty, loving personality, and famed cooking ability have been an additional asset to my efforts. My love for her and with her is multiplied by our young son — Gyromas — of two years. I have named my son after my work and for him I have written a song concerning his special name which I sing to him to inspire and awaken his young mind.

To Mr. Garland Robinette I owe a special thanks and my respect. As a top news anchorman with WWL-TV in New Orleans, Mr. Robinette has conducted himself in a more scientific manner with respect to discovering the truth of the operability of my energy machine than have most of the scientists who have seen or heard Mr. Robinette's news coverage of this invention. Mr. Robinette's extremely professional work not only *triggered* the involvement of other news media and scientists, but his work also led to financial assistance becoming available. Mr. Robinette spoke out when others were petrified to do so and his news coverage was based on *facts*, not wild speculation, biases, and prejudices. Mr. Robinette is a compliment and asset to his profession. In addition, Mr. Robinette is a very special person who truly cares about the benefits of my Invention to you, the *People*.

To Mr. Evan Soule', Jr. — a talented teacher and artist in New Orleans — I also owe special thanks and respect. Mr. Soule' has edited this Book and prepared all the finished drawings which are extremely professionally executed. Mr. Soule' has performed far more than this. He has put his very Essence into the editing, preparation, and production of this Book in order to enable it to be as appealing as possible to the reader. Mr. Soule' has fought vigorously with his pen against some of my unscrupulous adversaries. He has also vigorously discussed and endorsed my work with other scientists and members of the news media. Mr. Soule' is a special person who continuously works on behalf of my innovations becoming a reality for you, the *People*.

I wish to sincerely thank and give respect to the numerous scientifically-educated individuals listed in Chapter Seven who had the Scientific Courage to speak out on my behalf when it was not fashionable. All of these individuals are a compliment to the word "Scientist."

My very special thanks to Dr. Robert Smith of NASA, Dr. Roger Hastings of Sperry-Univac, and Engineer Milton Everett, formerly with the Mississippi Department of Energy — who spoke out first.

Joseph Westley Newman

Table of Contents

Chapter	Page
1. THE PROPER HISTORICAL PERSPECTIVE	1
2. GYROSCOPIC ACTIONS	4
3. TECHNICAL DESCRIPTION OF DRAWINGS	12
4. EXPLANATION FOR A WORKING INVENTION	15
5. DECLARATION BY DR. ROGER HASTINGS FOLLOWING EXTENSIVE TESTING ON 5,000 AND 900 LB. UNITS	22
6. DESCRIPTION OF SMALLER UNIT WITH AN AFFIDAVIT BY DR. ROGER HASTINGS	36
7. ADDITIONAL AFFIDAVITS	40
8. ANALOGIES USEFUL IN UNDERSTANDING THE TECHNICAL SYSTEM	49
9. EXPLANATION OF INTERNAL ACTION WITHIN MY ENERGY MACHINE AND DISCUSSION OF COMMUTATOR DESIGNS	60
10. QUANTUM MECHANICS	71
11. LIGHT	74
12. USEFUL "WORK, FORCE, AND POWER" EQUATIONS	80
13. THE STATIC EMBODIMENT (ENERGY MACHINE)	83
14. EFFECTS DEMONSTRATED BY PARTICLES WITHIN ELECTROMAGNETIC FIELDS	85
15. THE GAS EMBODIMENT (ENERGY MACHINE)	88
16. GRAVITY	91
17. INERTIA	96
18. HEAT AND THE THREE LAWS OF THERMODYNAMICS	102
19. ASTRONOMY	112
20. ACHIEVEMENT VS. APATHY	154
21. THE PROPER TEACHING SYSTEM	238
22. RECOMMENDED PROOF OF GOD'S EXISTENCE	243
23. THE MERGER BETWEEN MECHANIZATION AND ECONOMICS	253
24. THE PATENT SYSTEM	258
25. THE JUDICIAL SYSTEM	274
26. THE PURSUIT OF TRUTH	280
27. APPENDIX	283

Chapter 1

THE PROPER HISTORICAL PERSPECTIVE

"I cannot conceive curved lines of force without the conditions of a physical existence in that intermediate space."

— Michael Faraday

In my search for Absolute Truth over the last nineteen years, I have often questioned why the conclusions I drew from present physics, electrical engineering, and astronomy teachings were not in accord with the scientific community's conclusions.

The difference lies in the fact that during the last twenty-three years I have made my livelihood solely from inventing. This is a profession that requires continual questioning as to "HOW" and "WHY," followed by deep, creative thought concerning realistic improvements.

In contrast, the present teaching system from grammar school through college is one of *memorization*. The more capable a student is in memorizing the textbooks used within educational institutions, the better grade he or she receives. Moreover, the time allotted for learning the basics in college is very hurried. There is little or no time for deep, creative thinking as to "HOW" and "WHY." This system has been, and continues to be, very detrimental to the progress of science.

The progress of our human species is dependent upon creativity undergoing a process of *continuing physical expansion*. All technically-oriented individuals have a sensitive and moral obligation to encourage the creative individual, in whom lies the future improvement of the human race. In many instances, the technological realization of a scientific concept will precede the scientific explanation or expectation by the scientific community or other technical individuals.

The facts relative to the history of the advancement in every aspect of science — medicine, physics, chemistry, astronomy, geology, electrical engineering — clearly show that because a subject matter is taught in accordance with a given line of thought at that instant in time does not make it fact.

However, even at this late date many individuals within the scientific community and other technical individuals have clearly taken the position that anything taught in a given instant in time *is* fact.

If there were any merit to such a blind attitude, then the Earth would be flat and it would also be the center of the Universe, because such a "belief" was rigidly taught in past years. Actually, the present electric motor or generator would not exist because, prior to 1820, the teachings at that time stated that there was no connection between magnetism and electricity.

There are now and have been those who have blindly taken the position that there is no credibility to my Technical Process which describes my Pioneering Inven-

tion of Patent Application Number 179,474. Especially pertinent is the fact that I have described in extensive detail how a magnetic field consists of particles with a mechanical, *gyroscopic-type action* which can be understood and predicted and which occurs at the speed of light. Furthermore, *the energy in a magnetic field is the energy which comprises the atoms of the material from which the energy comes and is literally Einstein's Equation of $E = MC^2$* . Consequently, the mass (in the form of a gyroscopic particle) must *move* in a given direction at C , or the speed of light, and it must also *spin* at the speed of light.

"The energy in a magnetic field is the energy which comprises the atoms of the material from which the energy comes and is literally Einstein's Equation of $E = MC^2$."

I wish to pay tribute to Michael Faraday, whose work stimulated my search, and to James Clerk Maxwell. Both of these great scientists have seen even farther into the future in a way in which they have yet to receive full credit and recognition.

The following facts concerning these prestigious men were discovered by me many years after I had originally begun my search:

The following quotations are from a book entitled *Michael Faraday* by L. Pearce Williams [published by Chapman and Hall, Ltd., London, 1965]. Essentially, Michael Faraday understood the lines of force as real physical entities. His position was not shared by most other scientists of that time. This caused Faraday to remark on November 7, 1855:

"How few understand the physical lines of force! They will not see them, yet all the researches on the subject tend to confirm the views I put forth many years since. Thompson of Glasgow seems almost the only one who acknowledges them. He is perhaps the nearest to understanding what I meant. I am content to wait convinced as I am of the truth of my views." (page 507)

In correspondence between Michael Faraday and James Clerk Maxwell, Faraday disagreed at one point

with Maxwell's definition of the word "force." On page 514, Faraday states in a letter to Maxwell dated November 13, 1857:

"I [Faraday] perceive that I do not use the word 'force' as you [Maxwell] define it: 'the tendency of a body to pass from one place to another.' What I mean by the word is the source or sources of all possible actions of the particles or materials of the universe ..."

However, on the subject of the lines of force, Maxwell did agree with Faraday. On page 511, L. Pearce Williams writes:

"Maxwell, it would seem, was the only person besides Faraday who actually felt that the lines of force did exist and were not just an easy way to represent action at a distance."

The above quotations clearly show that Michael Faraday — possibly the greatest experimental genius that the world has ever known — strongly believed that the lines

at first hand. He combined the laws of electromagnetism into a simple, lucid mathematical statement — a set of famous relations known as Maxwell's equations. These provided the theoretical foundation of modern electromagnetic science — the basis of much, if not most, of our technological civilization."

Maxwell states on pages 72 and 73:

"I have hardly made a single experiment, and that the limit of my design is to show how, by a strict application of the ideas and methods of Faraday, the connection of very different orders of phenomena which he has discovered may be clearly placed before the mathematical mind."

From page 125:

"This work is Maxwell's crowning masterpiece: 'The theory I propose may ... be called a theory of the Electromagnetic Field because it has to do with the space in the neighborhood of the electric

"How few understood the Physical lines of Force!" — Michael Faraday

of force of a magnet were real entities and consisted of some type of particles. He simply did not know how to mechanically explain or prove the existence of these particles.

Therefore, it is obvious from the above that Michael Faraday would have eagerly endorsed a consistent, *mechanical* explanation of these particles comprising the lines of force within a magnet which would *mechanically* explain why magnets and electrical charges attract and repel as well as why electric currents move in varying directions when a conductor moves relative to a given magnetic field.

In my original Disclosure Document (which is legally a part of my Patent Application) along with my Patent Application, I mechanically explain in detail all of the above — in addition to previously unexplained scientific observations — via *one, single mechanical explanation* of gyroscopic-type particles which comprise all matter (energy) in the Universe and generate all magnetic/electric fields. I will present a detailed, mechanical description of these particles in this Book, beginning with Chapter Three.

The following quotations are from a book entitled *James Clerk Maxwell: a Biography* by Ivan Tolstoy. [Published by Canongate Publishing, Ltd., Edinburgh, 1981.]

From pages 2 and 4:

"Maxwell was, and largely remains to this day, a physicist's physicist — appreciated and revered by those equipped to understand and savor his work

or magnetic bodies, and it may be called a Dynamical Theory, because it assumes that in that space there is **matter in motion**, by which the observed electromagnetic phenomena are produced.'" (Emphasis added.)

From page 125 continued:

"The storage of electromagnetic energy in the field is then discussed in terms which no longer require the aether model. After writing down his final relations for the electromagnetic field (Maxwell's equations), he puts it this way:

'I have on a former occasion attempted to describe a particular kind of motion and a particular kind of strain, so arranged as to account for the phenomena. In the present paper I avoid any hypothesis of this kind; and in using such words as electric momentum and electric elasticity in reference to the known phenomena of the induction of currents and the polarization of dielectrics, I wish merely to direct the mind of the reader to mechanical phenomena which will assist him in understanding the electrical ones. All such phrases in the present paper are to be considered as illustrative, not explanatory.

'In speaking of the Energy of the field, however, I wish to be understood literally. All energy is the same as mechanical energy, whether it exists in the form of motion or in that of elasticity, or

in any other form. The energy in electromagnetic phenomena is mechanical energy. The only question is, Where does it reside? On the old theories it resides in the electrified bodies, conducting circuits and magnets, in the form of an unknown quality called potential energy, or the power of producing certain effects at a distance. On our theory it resides in the electromagnetic field, in the space surrounding the electrified and magnetic bodies, as well as in those bodies themselves, and is in two different forms, which may be described without hypothesis as magnetic polarization and electric polarization, or, according to a very probable hypothesis, as the motion and strain of one and the same medium.'" (Emphasis added.)

It is obvious from the above facts that Maxwell believed that there is *matter-in-motion in a magnetic field* and that there was some type of mechanical property which created the observed electromagnetic phenomena. Maxwell, like Faraday, simply did not know how to physically prove or mechanically explain the phenomena.

I was in the same intellectual position during March, 1965 when I read and studied the nature of Faraday's Generator. At that time, I also concluded that a magnetic field was composed of particles that possessed some form of mechanical action which created the observed results then being taught and accepted. In addition, I also concluded that these particles moved at the speed of light. However, like Faraday and Maxwell, I could not

sight, and, as a result, *still teaches the old theory* which Maxwell referred to as: "the form of an unknown quality called potential energy, or the power of producing certain effects at a distance."

[I will discuss in this Book the actual nature of "potential" energy as opposed to kinetic energy.]

The above facts clearly show that two of the most prestigious men of science — *before the fact* — already endorsed a basic tenet of my Disclosures. The above quotations, the factual results that will be presented in this Book, and the fact that as of this writing over thirty (30) extremely qualified, scientifically-minded individuals have put forth statements verifying that my technological prototypes have a greater energy output than external energy input into my system, most certainly overcome the objections of mere disbelief on the part of others who have not studied my concepts.

It is obvious that neither Maxwell or Faraday could mechanically explain or prove the existence of these particles, which I will discuss in this Book, nor did they understand or openly predict how one could obtain greater energy from a mass or magnetic field than the energy put into the system. Yet, these great men instinctively laid the ground work of endorsement for anyone who could mechanically explain these particles and therefore expand upon their own sincere and dedicated efforts to provide a mechanical explanation for electromagnetism.

I have accomplished this understanding and much more. By their statements, Faraday and Maxwell have ef-

***"In speaking of the Energy of the field, however, I wish to be understood literally. The energy in electromagnetic phenomena is mechanical energy."* — James Clerk Maxwell**

prove that my Hypothesis was true at that time. I then realized that one must mechanically understand the *essence of these particles* before one could efficiently harness their energy. I eagerly accepted this massive challenge and for well over a decade I studied, experimented, and put forth deep, creative thought which resulted in the (U.S. Patent Office) Disclosure Document of over 130 pages and the patent application Serial No. 179,474*. This in turn resulted in my developing a Unified Field Theory which was no longer only a theory **but a Technical Process which demonstrates and teaches the mechanical disclosure of a new source of energy and is so disclosed in this Book.**

It is historically apparent that because Faraday and Maxwell could not prove or mechanically explain these energy particles, the present scientific community has not grasped the essence of Maxwell's and Faraday's in-

fectively endorsed a basic tenet of my Disclosures before the fact, even though they had no explicit, mechanical explanation for their statements.

The importance, originality, and factual corroboration of my Disclosure will speak for itself.

SURELY I AM ENTITLED TO PIONEERING PATENT PROTECTION FOR THIS REVOLUTIONARY INVENTION.

*This application is a continuation-in-part of the prior copending application Serial No. 110,834, filed January 9, 1980, which in turn is a continuation-in-part of prior patent application Serial No. 23,136, filed March 22, 1979, and Serial No. 25,907, filed April 2, 1979.

Chapter 2

GYROSCOPIC ACTIONS

"The way in which Faraday made use of his lines of force in co-ordinating the phenomena of electric induction shows him to have been a mathematician of high order, and one from whom the mathematicians of the future may derive valuable and fertile methods."

— James Clerk Maxwell

I will begin with the scientific facts concerning my initial reading in March, 1965 on the nature of Michael Faraday's Generator.

Anyone who cannot recognize the veracity of certain conclusions that I understood when I initially studied Faraday's facts has been unjustly influenced by the teaching process which rewards one for memorization and discourages questioning of the subject matter taught.

As you read the following list of experimental facts concerning Faraday's generator, you will retrace the steps of my initial readings during March 1965. With open eyes and an open mind, question for yourself what would happen under the conditions described below.*

The facts of Faraday's Generator:

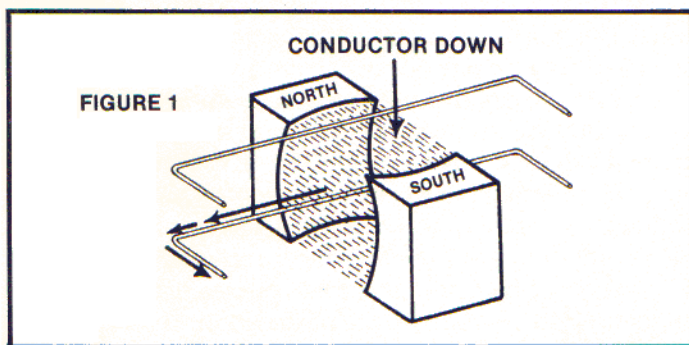

1. Push a conductor wire down and through a magnetic field at right angles to the lines of force and the electric current will flow to the left as drawn.

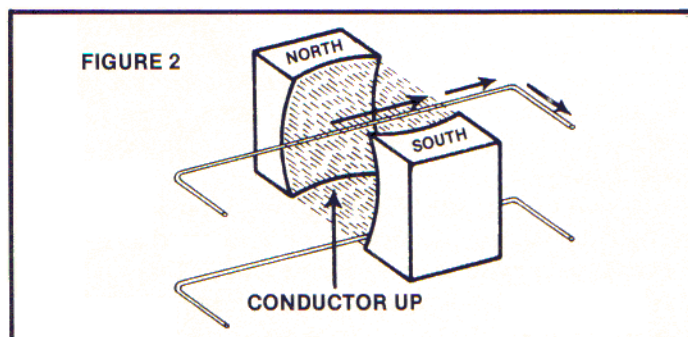

2. Push a conductor up and through a magnetic field at right angles to the lines of force and the electric current flows to the right as drawn (opposite to Figure 1 above).

*This openmindedness to new knowledge may be difficult for those taught by a system which rewards memorization and discourages the very type of questioning employed by the Author.

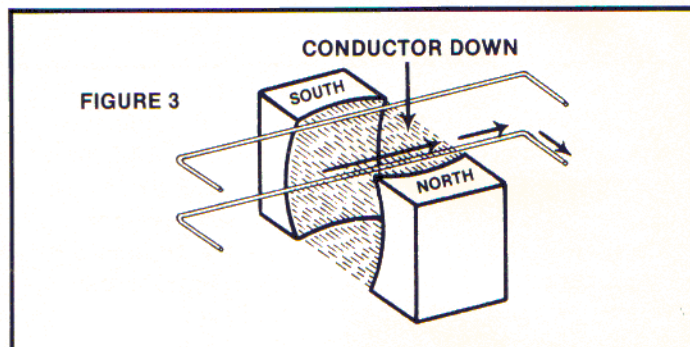

3. Flip over the magnet 180° and the direction of the electric current flow will be reversed from that of Figures 1 and 2 above, although the direction and motion of the conductor remain the same (compare Figure 3 to Figure 1 and observe opposite results).

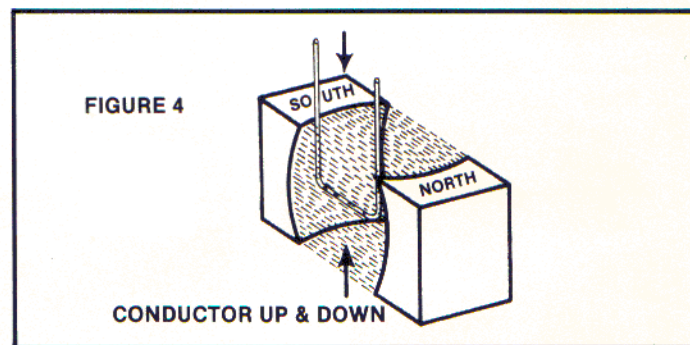

4. Push the conductor "down" or "up" in a motion parallel to, and through the magnetic lines of force: no electric current will flow despite a vigorous or energetic pushing effort.

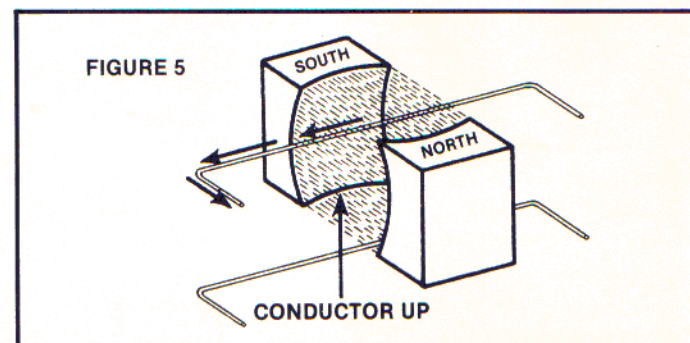

5. However, although the conductor can be very slowly pushed at right angles to the magnetic lines of force, the resulting electric current will move at the *speed of light*.

FIGURE 6

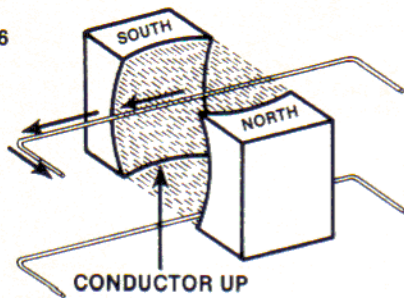

6. The conductor can be disconnected from the ammeter, flipped over 180° , reconnected to the ammeter to repeat the same motions of the conductor through, and at right angles to the magnetic lines of force (as in Figures 1-3). Identical results of the electric current flow will then be observed even though the conductor has been flipped over 180° . (See Figures 5 and 6: the conductor in Figure 6 has been flipped over 180° from that of Figure 5, yet the direction of current flow is identical.)

7. The conventional teachings would suggest that the above-discussed electric current flow was a result of electron flow in the conductor and that *nothing* came from the magnetic field. Also, conventional teachings state that the magnetic lines of force are imaginary, consisting of Potential Energy and *no* Kinetic Energy. [This claim was believed to be justified because no current flow was observed when the conductor was motionless in a magnetic field. There is no merit to this position when one knows that one can vigorously move a conductor parallel to magnetic lines of force and no current flow will occur.]

8. As I studied the above facts of Faraday's Generator, I concluded that the conventional teachings of No. 7 above were totally incorrect and that such a conclusion completely ignores the known facts presented by Faraday's Generator.

9. Facts 1-6 above clearly proved to me that a magnetic field consists of:

A. particles which have mechanical characteristics. I asked myself, "How else could these particles 'know' which way to travel and why else would the direction of current flow be so dependent upon the magnetic field and totally independent of the conductor itself?"

B. particles moving at the speed of light within the magnetic field. The facts prove to me that one did not impart the velocity of light to electric current flow by moving a conductor slowly through a magnetic field. Rather, the facts demonstrated that the resulting electric current flow consisted of an entity which already traveled at the speed of light. The slow movement of the conductor at right angles to that entity had simply mechanically deflected the particle from its normal path. [Such action is similar to that of a bullet being deflected by hitting a metal plate or body of water at

the proper angle which results in the bullet being deflected from its original path.]

However, I was still puzzled. I asked myself, "Why did the up and down motion of the deflecting conductor produce opposite-direction deflection of this mechanically-natured particle which moved at the speed of light? Why did the deflection reverse when the magnet was flipped over 180° ? And why, when the conductor moved parallel to these mechanically-natured particles (which were moving at the speed of light), was no current flow produced?" This latter question indicated to me that no proper deflection of the particles occurred in the mechanical position of force of the conductor.

Also, I asked myself, "When the conductor was motionless in the magnetic field (consisting of particles with mechanical characteristics and moving at the speed of light), why was no current flow produced?" This observation indicated that there was no proper deflection of the particles occurring in the mechanical position of the conductor.

10. Summation of my thoughts in the early months of 1965:

Faraday had invented an important invention — the electric generator — but he had invented an *inefficient* invention because one always obtained less energy from a system than the energy put into that system: yet, the facts clearly showed that the system consisted of an orderly flow of *Kinetic Energy*. This Kinetic Energy consists of a mechanically-oriented particle which moves at the speed of light. Therefore I knew that in order to construct the proper technological mechanism which could utilize this energy, I must simply understand the essence of the entire system.

In addition to making my living by other successful inventions, the next three years consisted of thousands of hours of testing, studying, and thinking to search for the truth concerning the nature of this mechanically-oriented particle. During this time, the same question dominated my thoughts: How did the particles of a magnetic field "know" which way to travel? In retrospect, the answer is extremely simple, but seemed very difficult to me at the time since I had never taken a physics course and had been teaching myself many varied subjects.

At this time in my life, I began to work on another invention consisting of a flywheel which acted as a "mechanical storage battery" for a bicycle. This flywheel caused the bicycle to automatically react as a "wheelie." Such "stored mechanical energy" within the flywheel suggested to me the stabilizing influence of a gyroscope. I then became fascinated with understanding the essence of the gyroscope and thereafter I learned the answer to the questions dominating my thoughts concerning the explicit, mechanical characteristics of the particles comprising a magnetic field and traveling at the speed of light.

11. These particles consist of a gyroscopic mechanical action which can be operationally (mechanically) understood and predicted! Let the following facts prove or disprove this Theory:

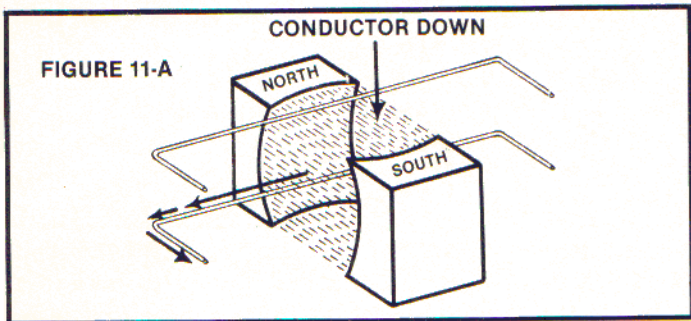

Figure 11-A Move a conductor down at a right angle to a magnetic field and *the current flow moves left.*

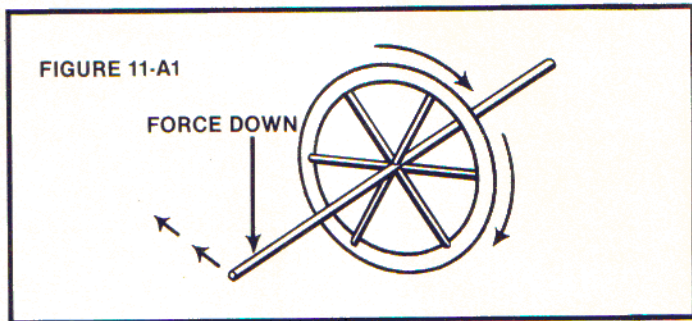

Figure 11-A1 Apply a downward force to the axis of a spinning gyroscope and it will pivot at a right angle to the force (in this case *pivot left*). Now imagine that this gyroscope has a forward direction at the speed of light.

THE ANALOGY OF THE ABOVE TWO EXAMPLES IS SCIENTIFICALLY EXACT!

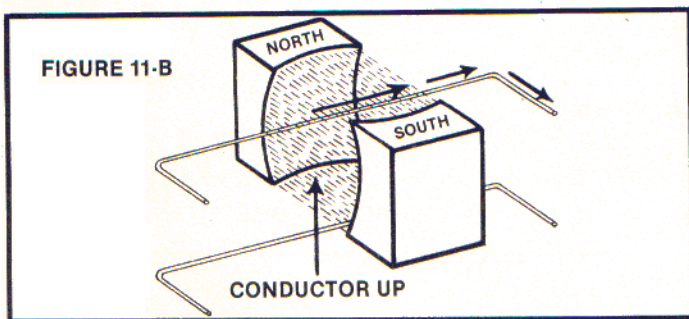

Figure 11-B Move the conductor "up" at right angles to the magnetic field and *the current flows right* and opposite to Figure 11-A above.

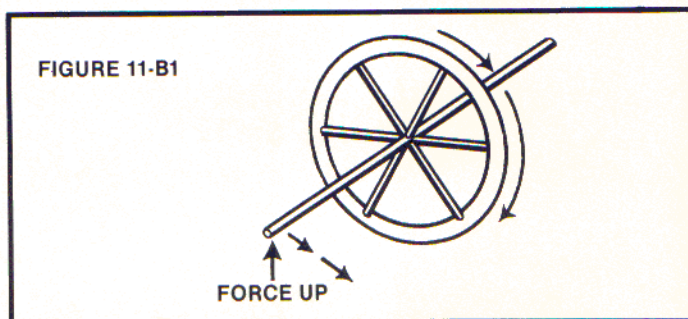

Figure 11-B1 Apply an upward force to the axis of the spinning gyroscope and it will pivot at right angles to the force. In this case, the gyroscope *pivots right* and opposite to Figure 11-A1 above. Now imagine that this gyroscope has a forward direction at the speed of light.

AGAIN, THE ANALOGY OF THE ABOVE TWO EXAMPLES IS SCIENTIFICALLY EXACT!

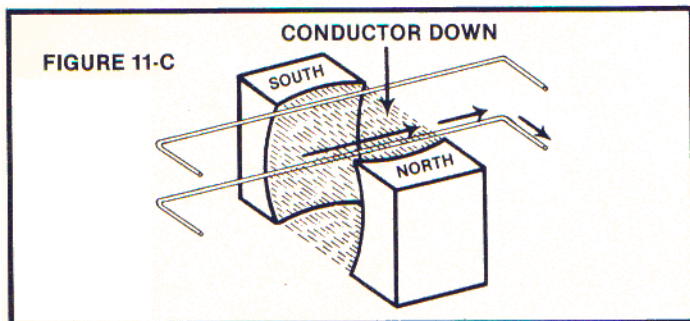

Figure 11-C Flip the magnets over 180° and repeat the actions of Figure 11-A above. The current flow direction will be *right and opposite* to that of Example 11-A even though the force direction is the same.

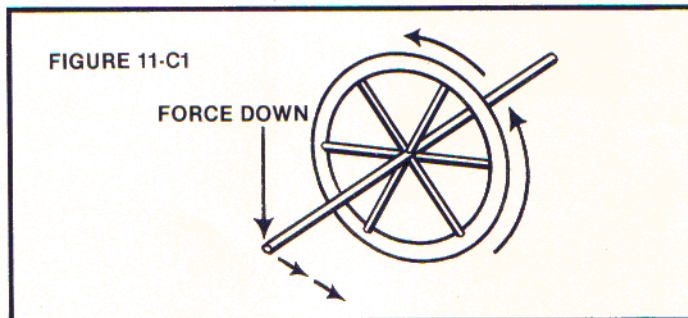

Figure 11-C1 Flip the spinning gyroscope over 180°. Repeating the actions of Figure 11-A1 above, *the gyroscope will pivot at right angles to the force, but will now pivot right and opposite* to that of Figure 11-A1 above, even though the force direction is the same. Now imagine that this gyroscope has a forward direction at the speed of light.

AGAIN, THE ANALOGY OF THE ABOVE TWO EXAMPLES IS SCIENTIFICALLY EXACT!

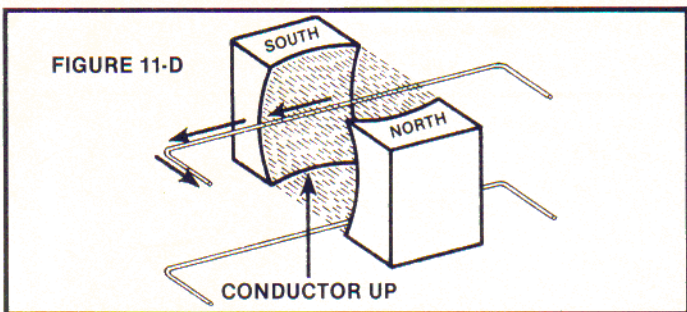

Figure 11-D Repeat the actions of Figure 11-B and the current flow will be left and opposite to Figure 11-B even though the force direction is the same.

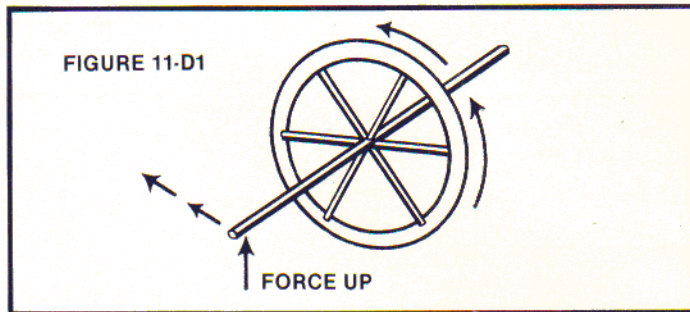

Figure 11-D1 Repeat the actions of Figure 11-B1: the gyroscope will pivot at right angles to the force, but will now pivot left and opposite to Figure 11-B1 even though the force direction is the same. Now imagine that this gyroscope has a forward direction at the speed of light.

AGAIN, THE ANALOGY OF THE ABOVE TWO EXAMPLES IS SCIENTIFICALLY EXACT!

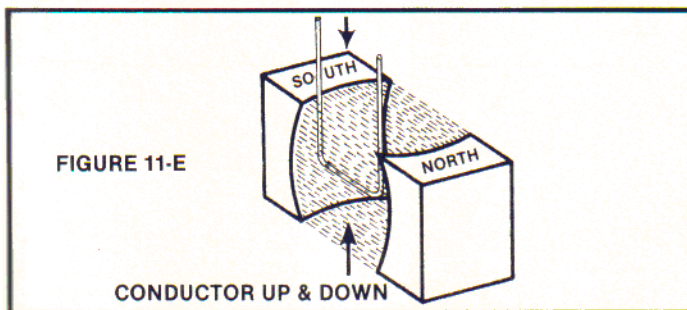

Figure 11-E Move the conductor vigorously "up" and "down" through the magnetic field, maintaining the conductor force parallel to the magnetic lines of force and no current flow will result.

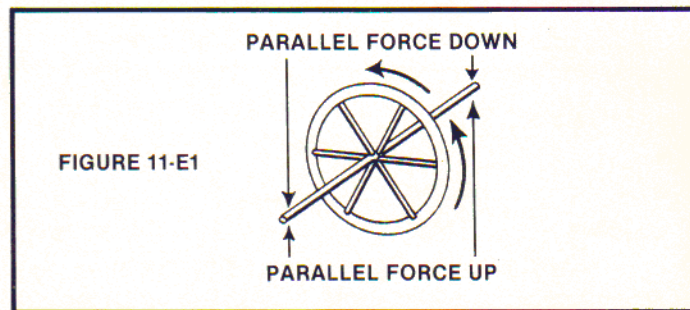

Figure 11-E1 Apply an "up" and "down" force parallel to the axis of the spinning gyroscope. Regardless of how energetically the force is applied, as long as the force remains parallel, the gyroscope will not pivot even though it has a forward motion at the speed of light.

AGAIN, THE ANALOGY OF THE ABOVE TWO EXAMPLES IS SCIENTIFICALLY EXACT!

"These particles consist of a 'gyroscopic mechanical action' which can be operationally (mechanically) understood and predicted!"

¹¹
F. The reason that a stationary conductor in a magnetic field (generated by and consisting of gyroscopic particles spinning and moving at the speed of light) does not produce current flow is very simple. The fundamental Laws for the Mathematics of Probability (Statistics of Large Numbers) states that as many of the gyroscopic particles will pivot left as pivot right due to the random motion of the atoms comprising the conductor. Such action causes a cancellation effect. The same is true if, from all directions, one randomly applies a force to the axis of a spinning gyroscope. It simply will not pivot if the random forces are fast.

AGAIN, THE ANALOGY OF THE ABOVE TWO EXAMPLES IS SCIENTIFICALLY EXACT!

¹¹
G. When one brings a conductor "down" or "up" at right angles to a magnetic field, the random motion of the atoms within the conductor does not affect the system because there is a general drift direction of the "up" and "down" force applied to the gyroscopic particles comprising a magnetic field. This effect is similar to an airflow consisting of gas molecules in random motion within the airflow, but also possessing a general drift direction which will apply a force to a windmill, etc. If the airflow ceases, however, the windmill will not turn even though the molecules of gas — while still moving at high velocities — are nonetheless in a random motion which cancels the force applied to all sides of the windmill.

The same effect is true if one applies a random force to the axis of a gyroscope. If the random force has a given drift direction of force, the gyroscope will pivot at right angles to that drift directional force.

AGAIN, THE ANALOGY OF THE ABOVE TWO EXAMPLES IS SCIENTIFICALLY EXACT!

At this point in time, the facts I had assembled had convinced me that my initial thoughts in 1965 were indeed correct. A magnetic field *does* consist of discrete particles which move forward at the speed of light and possess mechanically-identifiable characteristics which are identical to those possessed by a gyroscope. Such characteristics can be mechanically understood and predicted.

By this time, however, I also mechanically explained other questions which I had conceived regarding the nature of a magnetic field. Questions such as:

Why, in a mechanical sense, does a magnet attract and repel other magnets?

Why, in a mechanical sense, do electric charges attract and repel?

What is the energy in a magnetic field and what is its source?

Did the energy used in creating a permanent magnet have any bearing upon the strength or energy contained within a magnetic field emitted from the permanent magnet once it was made?

12. In the early part of 1965, I eagerly researched the known facts concerning the creation of a permanent magnet. Because I instinctively knew that if the strength of a magnetic field was solely relative to the energy input, then I would know I was incorrect. But if the strength of the magnetic field was *independent* of the energy input, then I would be even more assured that I was correct.

Upon examining the known facts concerning permanent magnets, I again knew I *was* correct and such facts are listed as follows:

12
A. For a given energy input into varying materials of identical volume, the generated strength of the magnetic field varies drastically!

The same electrical energy input created extremely variable field strengths! I therefore instantly knew that the strength of the magnetic field had to be a result of the nature of the atoms comprising the material and *not* a result of the electrical energy input.

12
B. The facts further demonstrated that the strength of the magnetic field was observed to increase as more atoms within the material became aligned!

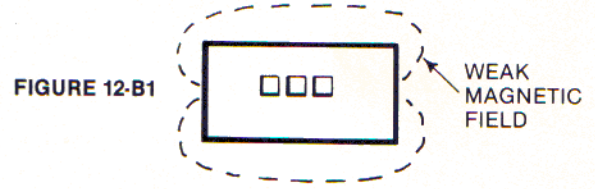

FIGURE 12-B1

FEW ATOMS ALIGNED

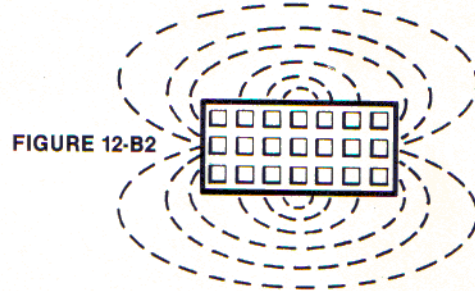

FIGURE 12-B2

GREATER ATOM ALIGNMENT
PRODUCES STRONG MAGNETIC FIELD

FACT B therefore further corroborated FACT 12-A above as being correct.

12
C. The facts also taught that once the maximum atom alignment of a given material was achieved, then *no* amount of electrical input would continue to increase the magnetic field of that material! (See Figure 12-B2 above.)

It was obvious to me from this conclusion that the strength of the magnetic field of a given material was not relative to the electrical energy input. Once the maximum atom alignment of a material was achieved, one could increase the energy input 1000 times and there would be *no* increase in the strength of the magnetic field of the permanent magnet. Therefore, FACT 12-C further corroborated FACT 12-A above.

12
D. The facts also taught that if one took a permanent magnet (such as in Figure 12-D1 below) which has a strong magnetic field and heated the magnet to its Curie temperature, the magnetic field would virtually disappear! (See Figure 12-D2 below.)

FIGURE 12-A1

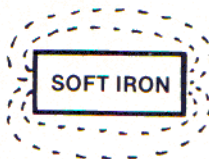

PRODUCES WEAK, PERMANENT MAGNETIC FIELD

FIGURE 12-A2

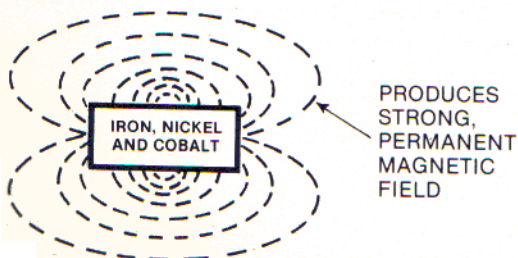

PRODUCES STRONG,
PERMANENT
MAGNETIC
FIELD

FIGURE 12-D1

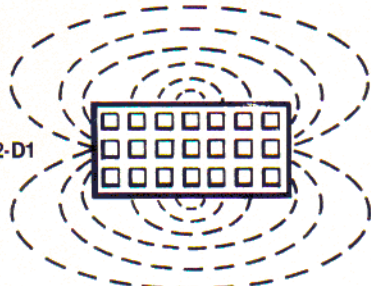

STRONG MAGNETIC FIELD PRODUCED BY GREATER ATOM ALIGNMENT

FIGURE 12-D2

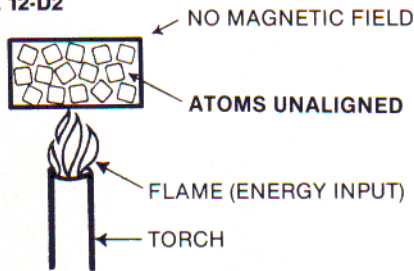

Again, it was obvious to me that the magnetic field disappeared in Figure 12-D2 because the heat input created a random atomic motion and non-alignment within the material. One can clearly see that in Figure 12-D2 one is transferring energy into the system of the magnetic material, *i.e.*, one is not taking energy from the magnetic material and yet the magnetic field virtually disappears.

13. The conclusions which I drew from the above FACTS 1-12D clearly proved to me the following:

A. The energy in a magnetic field is the energy which comprises the component parts of the atoms from which the energy comes!

B. The energy in a magnetic field is therefore literally Einstein's Equation of $E = MC^2$!

C. The energy in a magnetic field must be moving in a direction at the speed of light and must also have a gyroscopic spin at the speed of light: *herein lies the mechanical essence of $E = MC^2$!*

The Kinetic Energy of a moving particle is $\frac{1}{2}MV^2$. If the particle is moving with speed V and also rotating about its axis at speed V , then the total Kinetic Energy is $\frac{1}{2}MV^2$ (for forward motion) plus $\frac{1}{2}MV^2$ (for the rotational motion [not $\frac{1}{2}I\omega^2$]) which equals MV^2 . If V is equal to C , then the total Kinetic Energy is equal to MC^2 . (Hypothetically, this particle is mathematically

an infinitely small entity which, in a literal and mechanical sense, moves laterally and rotationally to generate a gyroscopic [spiral] helix effect.)

D. The literal and mechanical configuration of a magnetic field is simply a result of the summation of atom alignment within the material from which the magnetic field is generated.

E. At this time, I had also mechanically explained why electric charges as well as magnets attracted and repelled. (Conventional teachings only state that "like" magnetic poles repel and "unlike" magnetic poles attract. It is also said that "like" electrical charges repel and "unlike" electrical charges attract. This is a superficial analysis.) The answer to such attraction/repulsion is simple. The gyroscopic spin has a mechanical action which causes the observed results and can be mechanically understood and predicted.

F. The same conventional and superficial analysis was also applied to electric charges, *i.e.*, "like" charges repel and "unlike" charges attract. My mechanical explanation concerning electric charges was developed 1½ years before I understood the gyroscopic composition of magnetic fields. In essence, I mechanically viewed the electric charges as rotating arrows  similar to the mechanics of gear interaction. This enabled me to easily envision and draw the mechanical effects of attraction and repulsion. However, I did not call this mechanical effect of attraction and repulsion a gyroscopic effect since (at that time) I had still not studied gyroscopes. Upon understanding gyroscopes, I instantly understood that the mechanics I had originally drawn for electric charges was a gyroscopic action. The fact that the same mechanical explanation for gyroscopic action explained *both* magnetism and electric charges made me even more certain of the correctness of the mechanical explanation. [Electric charges consist of millions (plus) of gyroscopic particles and such charges will be discussed in more detail in a later chapter (Sections 29 A-M) discussing gravity.] At this point, you should first intellectually master the concept and mechanical nature of magnetism.

The following two pages of drawings describe MAGNETS IN REPULSION and MAGNETS IN ATTRACTION, (as well as electrical repulsion and attraction), visually explaining the discussion in 13 A-E. These drawings have been unselfishly produced for me by Mr. Evan R. Soule', Jr. (talented artist and teacher). See also the following pages presenting a Technical Description of the drawings. This Technical Description was also unselfishly written by Mr. Evan R. Soule', Jr. from information developed by me, with the purpose being that if Mr. Soule' could understand what I have taught, then as an experienced teacher he could put forth this information so that you, the reader, would also understand.

MAGNETIC FIELDS IN REPULSION

QUALITATIVE REPRESENTATION OF THE KINETIC ENERGY OF A MAGNETIC FIELD: GYROSCOPIC FUNDAMENTAL PARTICLES SIMULTANEOUSLY ROTATING (ON AN AXIS CONSISTING OF A GIVEN "LINE OF FORCE") AT THE SPEED OF LIGHT AND TRAVELING AT THE SPEED OF LIGHT ALONG THESE "LINES* OF FORCE" IN ACCORDANCE WITH EINSTEIN'S EQUATION OF $E=MC^2$

— "ACTUALLY "SHELLS OF FORCE"

IT IS THE GYROSCOPIC SPIN THAT PLAYS THE MAJOR ROLE OF ATTRACTION AND REPULSION IN MAGNETIC FORCES (EXACTLY AS SHOWN IN STATIC ATTRACTION AND REPULSION — SEE "PROOF A")

© COPYRIGHT, 1984, JOSEPH NEWMAN (LUCEDALE, MS)

Drawn by Evan Soule, Jr. (New Orleans, LA) based upon the original and copyrighted concepts of JOSEPH NEWMAN.

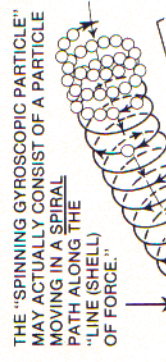
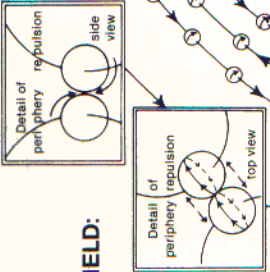
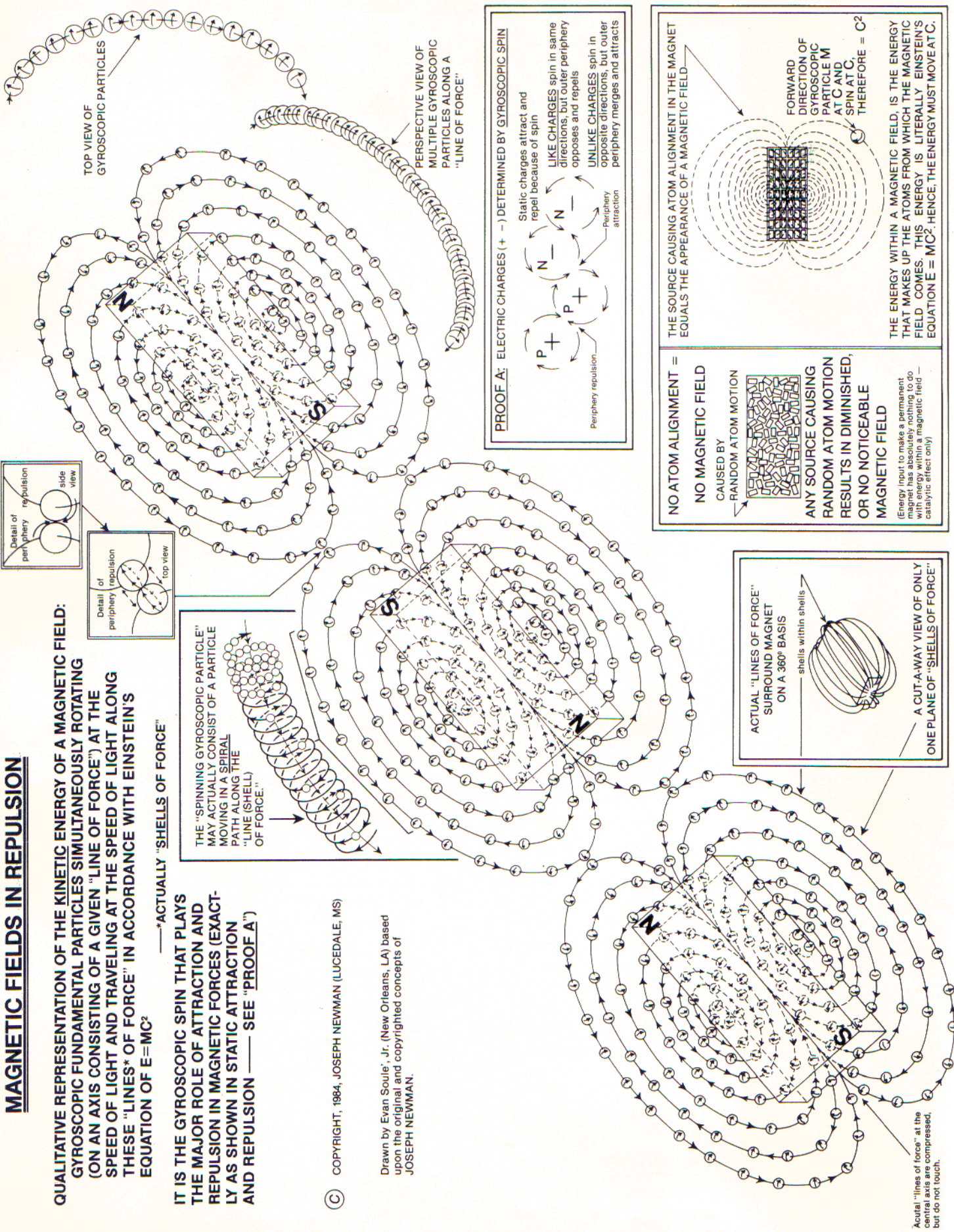

PROOF A: ELECTRIC CHARGES (+ -) DETERMINED BY GYROSCOPIC SPIN

Static charges attract and repel because of spin

LIKE CHARGES spin in same directions, but outer periphery opposes and repels

UNLIKE CHARGES spin in opposite directions, but outer periphery merges and attracts

Periphery repulsion.

Periphery attraction.

NO ATOM ALIGNMENT = NO MAGNETIC FIELD

CAUSED BY RANDOM ATOM MOTION

ANY SOURCE CAUSING RANDOM ATOM MOTION RESULTS IN DIMINISHED, OR NO NOTICEABLE MAGNETIC FIELD

(Energy input to make a permanent magnet has absolutely nothing to do with energy within a magnetic field — catalytic effect only)

THE SOURCE CAUSING ATOM ALIGNMENT IN THE MAGNET EQUALS THE APPEARANCE OF A MAGNETIC FIELD.

FORWARD DIRECTION OF GYROSCOPIC PARTICLE M AT C AND SPIN AT C. THEREFORE = C^2

THE ENERGY WITHIN A MAGNETIC FIELD, IS THE ENERGY THAT MAKES UP THE ATOMS FROM WHICH THE MAGNETIC FIELD COMES. THIS ENERGY IS LITERALLY EINSTEIN'S EQUATION $E = MC^2$. HENCE, THE ENERGY MUST MOVE AT C.

ACTUAL "LINES OF FORCE" SURROUND MAGNET ON A 360° BASIS

shells within shells

A CUT-AWAY VIEW OF "SHELLS OF FORCE"

Actual "lines of force" at the central axis are compressed, but do not touch.

MAGNETIC FIELDS IN ATTRACTION

QUALITATIVE REPRESENTATION OF THE KINETIC ENERGY OF A MAGNETIC FIELD: GYROSCOPIC FUNDAMENTAL PARTICLES SIMULTANEOUSLY ROTATING (ON AN AXIS CONSISTING OF A GIVEN "LINE OF FORCE") AT THE SPEED OF LIGHT AND TRAVELING AT THE SPEED OF LIGHT ALONG THESE "LINES* OF FORCE" IN ACCORDANCE WITH EINSTEIN'S EQUATION OF $E=MC^2$

IT IS THE GYROSCOPIC SPIN THAT PLAYS THE MAJOR ROLE OF ATTRACTION AND REPULSION IN MAGNETIC FORCES (EXACTLY AS SHOWN IN STATIC ATTRACTION AND REPULSION — SEE "PROOF A")

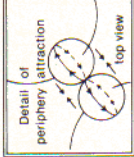
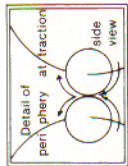
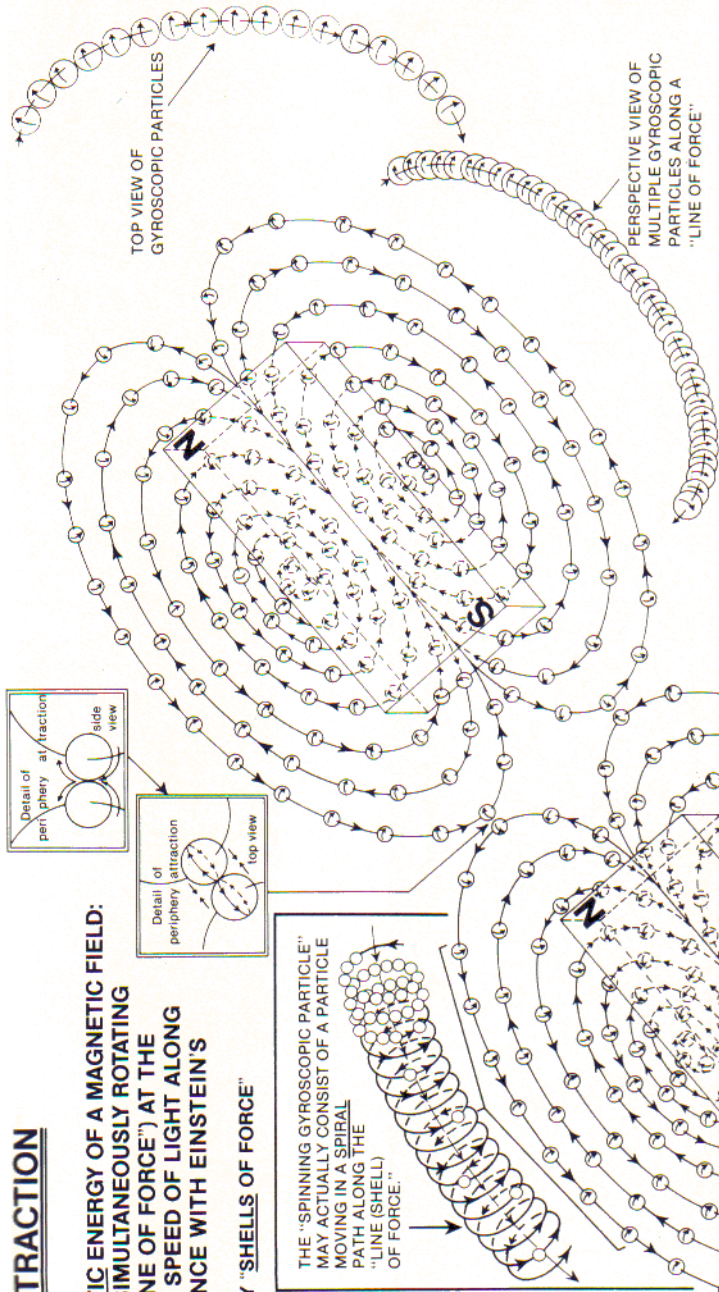

THE "SPINNING GYROSCOPIC PARTICLE" MAY ACTUALLY CONSIST OF A PARTICLE MOVING IN A SPIRAL PATH ALONG THE "LINE (SHELL) OF FORCE."

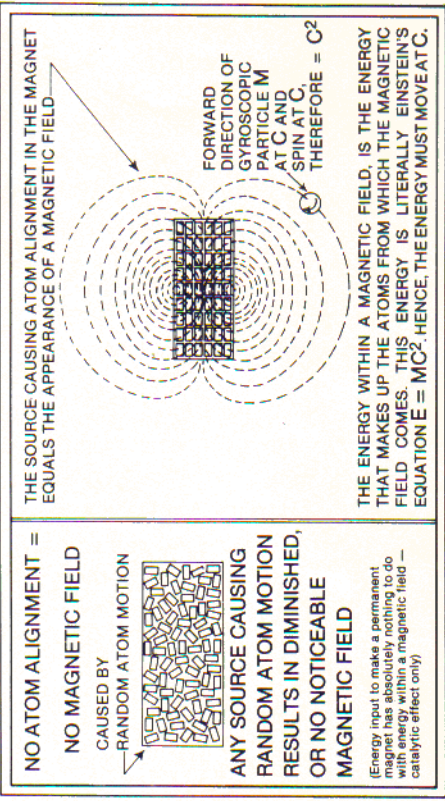
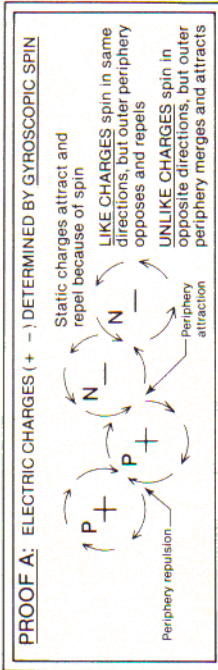

© COPYRIGHT, 1984, JOSEPH NEWMAN (LUCEDALE, MS)

Drawn by Evan Soule, Jr. (New Orleans, LA) based upon the original and copyrighted concepts of JOSEPH NEWMAN.

Actual "lines of force" at the center are compressed, but do not touch.

Described above are the technical drawings for one aspect of Joseph Newman's theories. The two drawings — MAGNETIC FIELDS IN REPULSION and MAGNETIC FIELDS IN ATTRACTION — describe three bar magnets in a three-dimensional configuration surrounded and penetrated by circulating gyroscopic particles, each of which spins while traveling upon "lines (shells) of force (direction)" that consecutively alternate in opposite directions. [The difference between the two drawings is that the central magnet is reversed.]

According to Mr. Newman, these gyroscopic particles are the smallest particles known and comprise all atoms within the universe. The technical drawings are *qualitative* in nature; quantitatively, there are trillions of such gyroscopic particles flowing in the described paths to generate the magnetic field. Although sub-atomic particles will be shielded by lead, the effects of magnetic fields can be observed through lead shielding. According to Mr. Newman, this is one proof that these particles are the most fundamental particles known.

These drawings represent the *first* time in the history of physics that there is presented in an explicit pictorial fashion (via the concepts innovated by Mr. Newman) a precise, mechanical explanation of the phenomena of magnetism and the principle of "action at a distance." In his researches on magnetism, James Clerk Maxwell (as well as Michael Faraday) *explicitly* described the lines of force surrounding a magnet as *kinetic, mechanical energy*. (Maxwell called electromagnetism "matter in motion.") This description by Maxwell has been forgotten in the past 100 years. While Maxwell could not explain in detail the action of a magnet, he did recognize that such action *is* mechanical in nature.

As one passes a conductor wire in front of and across the end of a bar magnet, one will observe the current to flow first in one direction, then become neutral, then reverse itself and flow in the opposite direction. This occurs due to the nature of the flow of the gyroscopic particles as they flow from each end of the bar magnet (see drawings above). On one side of the south (S) end of the bar magnet, for instance, the particles flowing in and out along the "lines of force" spin "up," while on the other side of the *same* south end, the particles flowing in and out along the "lines of force" spin "down." A spinning gyroscope will move at right angles to the force acting upon it; hence, as the gyroscopic particles encounter the particles composing the conductor wire, they

move "up" or "down" the conductor (at right angles to the direction that they first encounter the conductor).

Mr. Newman indicates that it is principally the *spin* of the gyroscopic particle (and *not* the direction of flow for the gyroscopic particles along the "lines of force") that determines magnetic repulsion and attraction. The interaction of the peripheries of the particles actually effects such repulsion and attraction (see PROOF A). Although the drawings depict space between the particles flowing in a given "line of force," in actuality the particles are more like individual spirals upon a strand of beads in the shape of a helix which results in a gyroscopic action — each particle "bumping against the next." [According to Mr. Newman, between each particle there is a very small amount of space created by the electromagnetic force surrounding each particle.]

As the drawings depict, the actual "lines of force" are really *shells of force* which envelop the magnets as discrete shells of gyroscopic particles which lie concentrically within other shells. These "lines of force" (as depicted in one plane on the drawings) or shells of force (in actuality) travel (rotate) in opposite directions relative to one another. The effect of such motion is to place the peripheries of respective gyroscopic particles (from one "line of force" to the next) at opposition (or repulsion) to one another and consequently keep each "line of force" separated from each adjoining (concentric) "line (shell) of force."

In addition, there are as many "lines of force" emanating from each end of the bar magnet as there are atoms aligned magnetically across the width and height of the N and S ends of the magnet. Because of the large size of iron filings relative to the sub-atomic size of the gyroscopic particles, the particles within the "line of force" congeal clumps of the filings into (via the naked eye) a relatively few number of such lines. With more finely-ground iron filings, more "lines of force" would become visible to the human eye.

Each particle (M) travels along the "line (shell) of force" at the speed of light (C) and also individually spins at the speed of light (C). Consequently, such motion results in energy (E) since $E = MC^2$.

It should also be noted that, based on the theories of Mr. Newman, I constructed three-dimensional models of two bar magnets to study how the gyroscopic particles interact. Using simple styrofoam (for the bar magnet), wire (for the "lines of force"), and wooden beads (for

the gyroscopic particles), I was able to construct these models as shown in the technical drawings. (This is only an analogous construction. Mr. Newman does not state there is a solid particle spinning on its axis as it moves, but probably is a particle moving [in effect, spinning] in a circular [spiraling helix] configuration at the speed of light and moving forward at the speed of light [within the general helix action]; such combined motion equals C^2 .) (See Figure 13-G.)

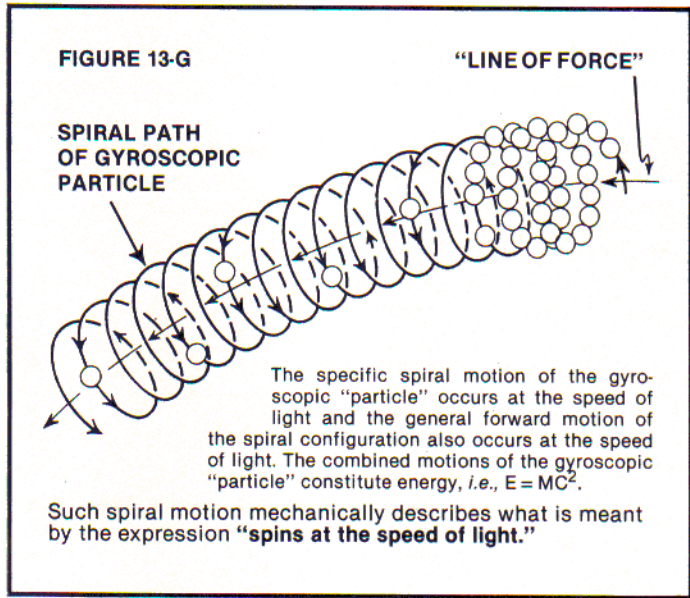

An interesting observation occurred following construction and study of these two models: while the N and S pole faces of two magnets (see Figure 13-H1) attract

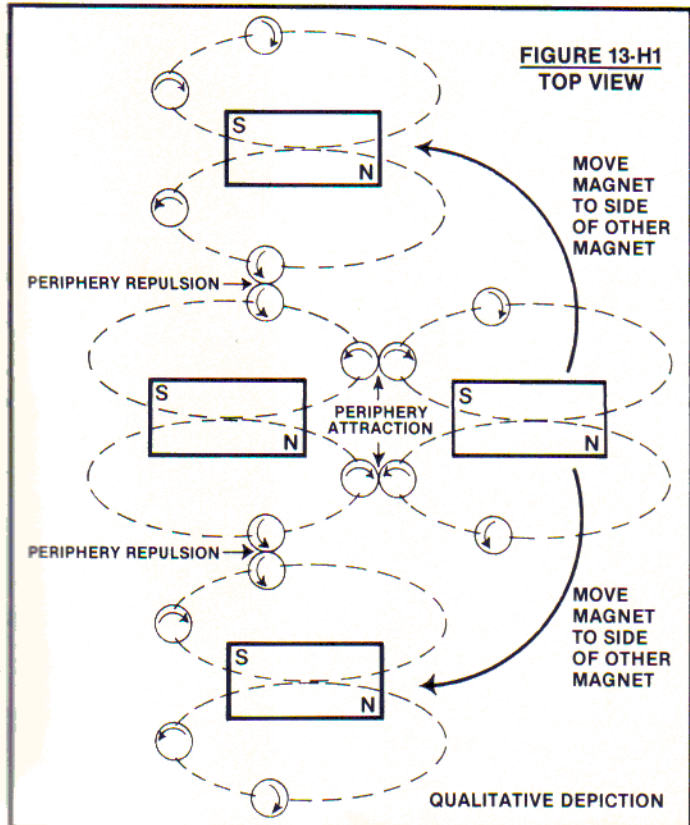

when placed directly *end-to-end*, if one shifts the same faces to the *side of one another* (keeping them in the same plane), one will notice that the periphery spin of the gyroscopic particles flowing from N and S will interact to *repel* one another, even though opposite poles normally attract one another in a *head on* position.

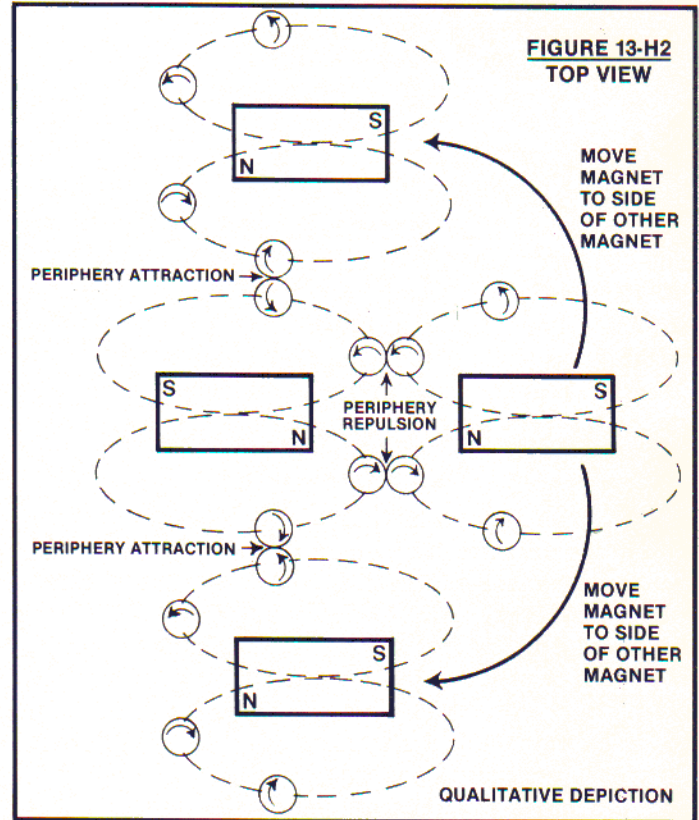

Similarly, with two like poles (see Figure 13-H2) brought together (N to N or S to S) — while they repel each other when placed *head on*, the models appeared to indicate that the magnets would attract each other when

This simple experiment to test the validity of an explanation for a previously unobserved (or if observed, then unexplained) magnetic phenomenon is a powerful corroboration for the rightness of Mr. Newman's theories.

the ends are placed slightly side to side (alongside one another and overlapping in the same plane.) For this writer, the *real test* was whether actual magnets behaved in this manner. In testing such magnets, I found that such *side attraction* (with N to N) and *side repulsion* (with N to S) was observed *exactly* as the mechanical descriptions of Mr. Newman would predict and indicate. This simple experiment to test the validity of an explanation for a previously unobserved (or if observed, then unexplained) magnetic phenomena is a powerful corroboration for the rightness of Mr. Newman's theories.

Technically speaking, like a water wheel harnessing the mechanical action of a river, Mr. Newman has effectively designed a machine capable of harnessing the above-described magnetic energy and converting it to useful electrical energy. Therefore, the produced electrical energy comes from the gyroscopic particles comprising the atoms of the magnet. A magnetic field is created (as the drawings indicate) when the atoms of a given material become aligned. According to Mr. Newman, the motion of the gyroscopic particles about the "lines (shells) of force" surrounding a magnet are a precise reflection of the interior, structural interaction of these particles within a given atom. The larger particles (quark, neutrino, meson, electron, proton, neutron, etc.) are various configurations and agglutinations of the gyroscopic particle. As the atoms become aligned within a magnet-to-be, they begin to act upon (and magnify) one another's individual, atomic, magnetic fields to integrate with one another until such fields completely mesh and expand to become the magnetic field of the complete magnet.

One may wonder that, if the magnets are depleted of their gyroscopic particles during the course of the operation of Mr. Newman's machine, will they not eventually lose their mass completely? The answer is yes, although because Mr. Newman's energy machine operates at 100% conversion efficiency (there being no radiation, heat, light, etc., as in nuclear fission reactions which operate at less than 1% efficiency), and because there are trillions plus gyroscopic particles within *each* atom, Mr. Newman estimates that it would literally be thousands of years before one would detect any significant, measurable amount of mass loss within a magnet.

It should be noted that Mr. Newman has worked on these ideas for 19 years. Mr. Newman submitted his theoretical discussion and proofs to the patent office several years *before* he constructed the actual working prototype of his energy machine. Mr. Newman was totally convinced of the rightness of his theories and did not need an operating machine to prove such rightness to himself. From his perspective, such a machine was needed as proof to everyone else.

It is Mr. Newman's position that from his various theories (of which this discussion about the [magnetic-field-creating] gyroscopic particles is only a *single* aspect of his theories) one should be able to understand that it would be possible to construct an energy machine that was capable of harnessing such (gyroscopic) energy if one could visualize the proper configuration of the materials necessary to effect such harnessing. Such configuration is the technical aspect of the Patent itself — technically independent of, but theoretically dependent upon, understanding the nature of the gyroscopic particles and how they interact with one another, especially since all atoms in the universe are composed of such particles.

Although this would be a separate (but physically-related) theoretical discussion, Mr. Newman has indicated that gravitation is the observed effect of the

interaction of unobserved electromagnetic fields (composed of gyroscopic particles) surrounding bodies in space. [Mr. Newman has theoretical concepts appropriate to this subject.]

As the drawings also indicate, positive and negative electrical charges are determined by the gyroscopic spin of individual particles, and such charges are repelled or attracted to one another according to periphery attraction (see PROOF A).

The fundamental, gyroscopic particle is, therefore, the unifying factor for the nuclear, electric, magnetic, and gravitational fields.

Evan R. Soule', Jr.
New Orleans, Louisiana (1984)

NOTE: To date, over thirty individuals have signed Affidavits attesting to the rightness of Mr. Newman's invention. These individuals include electrical engineers, physicists, inventors, scientists, and explicitly: Mr. Milton Everett (biomass energy specialist with the Mississippi Department of Energy), Dr. Roger Hastings (principal physicist for Sperry-Univac in St. Paul, Minnesota), and Mr. Eike Mueller (West German scientist and European Space Agency mission coordinator with the National Aeronautics and Space Administration).

Chapter 4

EXPLANATION FOR A WORKING INVENTION

"When a mathematician engaged in investigating physical actions and results has arrived at his own conclusions, may they not be expressed in common language as fully, clearly, and definitely as in mathematical formulae? If so, would it not be a great boon to such as well to express them so — translating them out of their hieroglyphics that we might also work upon them by experiment?"

— Michael Faraday to James Clerk Maxwell, 1857

I will now present an explanation for a working invention which utilizes the energy within magnetic fields and produces more energy than is introduced into the system from an external energy input. Do not at this point reflect poorly upon yourself and blindly state "perpetual motion." Simply put, the technological process which I will discuss converts mass into energy on a 100% conversion process via $E = MC^2$.

14. I believe it is imperative to reiterate that the energy in any magnetic field is the energy which composes the elements of the atom and is literally Einstein's Equation of $E = MC^2$. Such energy in the form of gyroscopic particles is the basic building block of all matter and provides the basis for the conceptual interface between energy and matter.

The following facts will clearly demonstrate a fundamental understanding which prepares the reader for a more thorough comprehension of how one technological embodiment of this Pioneering Invention can be built.

14 A. The prior teachings indicate that copper is non-magnetic and that the resulting magnetic field associated with current flow in copper is the result of the current.

14 B. Those teachings are totally wrong. Copper is extremely magnetic! It is so magnetic that it deceives the observer. *Example:*

Turn the current on as in Figure 14-B1 and a magnetic field will occur very quickly. Then turn the current off as in Figure 14-B2 and the magnetic field very quickly disappears with no remnant of the magnetic field observed in the copper material. If one then places a magnet close to the copper, it is not observed to be noticeably magnetic. Therefore, one is easily deceived since conventional, *so-called* magnetic materials generate a different result. *Example:*

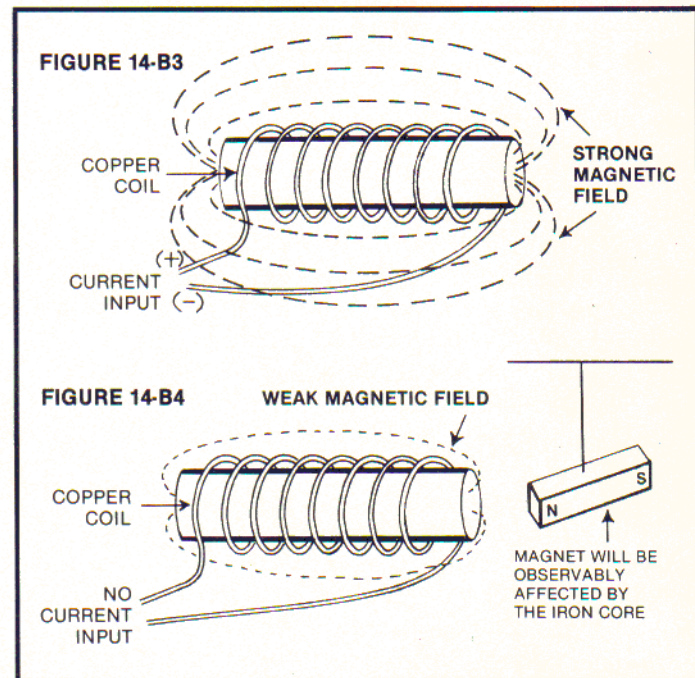
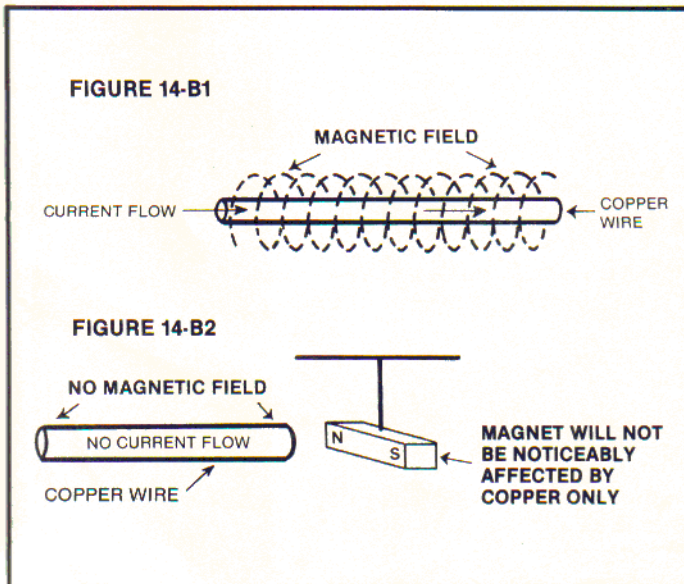

By placing an iron core within a copper coil (as in Figure 14-B3) and turning the current on, a significantly stronger magnetic field will be generated than in Figure 14-B1 [for the same energy input]. Now, turn off the current as in Figure 14-B4 and there will be a small, remnant magnetic field surrounding the iron core. If a magnet is placed near the iron core, the magnet will be visibly affected. However, one is easily deceived by these tests and can be misled into believing that copper is non-magnetic. This is exactly what happened to Hans Christian Oersted in 1820 when he first discovered that an electric current produced a magnetic field which would cause a magnet to align at right angles to the conducting wire. Oersted noted that the deflection of the magnet lasted only as long as the current was flowing through the conducting wire and hence, such magnetic action could not be

caused by the (copper) wire, but must be a result of the current itself. This same incorrect conclusion is still rigidly taught to this day.

The following facts will clearly prove that copper is *highly magnetic* relative to the speed of atom alignment/unalignment as well as the action/reaction effect of the energy release (in the form of the gyroscopic particles previously discussed) from the atoms comprising the copper wire!

“The prior teachings indicate that copper is non-magnetic and that the resulting magnetic field associated with current flow in copper is the result of the current. Those teachings are totally wrong. Copper is extremely magnetic! It is so magnetic that it deceives the observer.”

¹⁴ C. What the Prior Art teaches: Hypothetically, if one imposes current into a (copper*) conductor coil of pure inductance, the same current would be returned as that which was initially placed into the (copper*) conducting coil. (See Figures 14-C1 and 14-C2.)

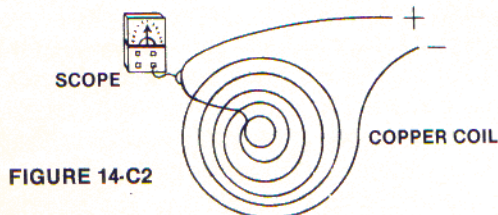
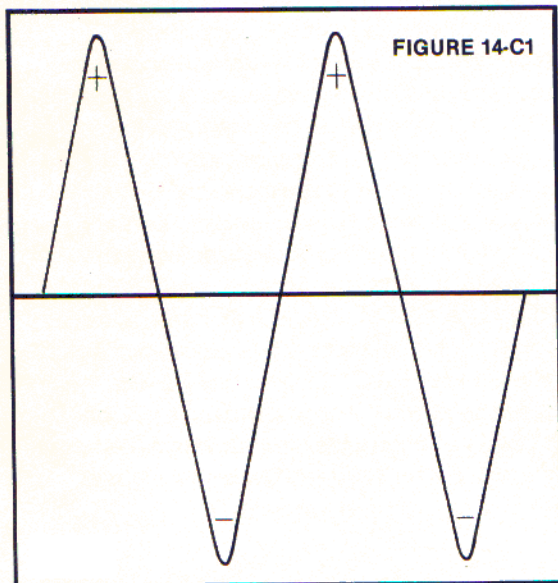

[*This process is in no way limited to copper. Actually, one can utilize *any* suitable materials for conducting, e.g., super-conducting materials such as niobium tin, etc.]

Physically speaking, this simply means that the energy contained within the magnetic field — when generated by positive (+) current flow in one direction — is returned by the collapsing magnetic field as negative (-) current flow when the current flow reverses direction.

¹⁴

D. The Prior Art also teaches Kircbhoff's Law which states: the same amount of current placed into a system (as a copper conductor) for a given-instant of time has the same amount of current flowing from that system (copper conductor) for the same given-instant of time. (See Figure 14-D.)

FIGURE 14-D

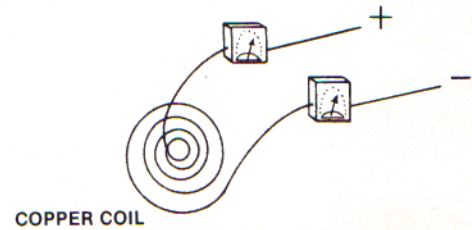

METERS SHOW SAME CURRENT OUT OF COIL AS CURRENT INTO COIL IN THE SAME INSTANT OF TIME

¹⁴

E. The above FACTS of 14C and 14D totally contradict the prior teaching that the magnetic field generated by the current flowing in a (copper) conductor is solely a result of the current itself and that copper is non-magnetic.

Look at the facts and open your mind!

The facts demonstrate the following: 14C above shows that if one inputs a given amount of current (X) into a copper coil during a given-instant of time then, as described in 14D above, the same amount of current (X) outputs from the copper coil during the same instant of time. In addition, 14C above also shows that if the current is then *cut off* and the coil shorted with meters in the line, then the same amount of current (X) will *now come from the copper coil*.

The facts therefore demonstrate: (X) current in and (X) current out *plus* (X) current out again when the (X) current input is stopped. These facts are therefore equivalent to 1 (X) amount of current *into* the coil (copper) and 2 (X) amount of current *out of* the (copper) coil.

QUESTION: *From where did the extra (X) amount of current coming from the copper coil emanate?*

ANSWER: By analogy, the Prior Teachings indicate that current is equivalent to the volume of water and that

voltage is equivalent to the pressure of water. Therefore, one should understand the essence of this analogy relative to the facts discussed above. (See Figures 14-E1 and 14-E2.)

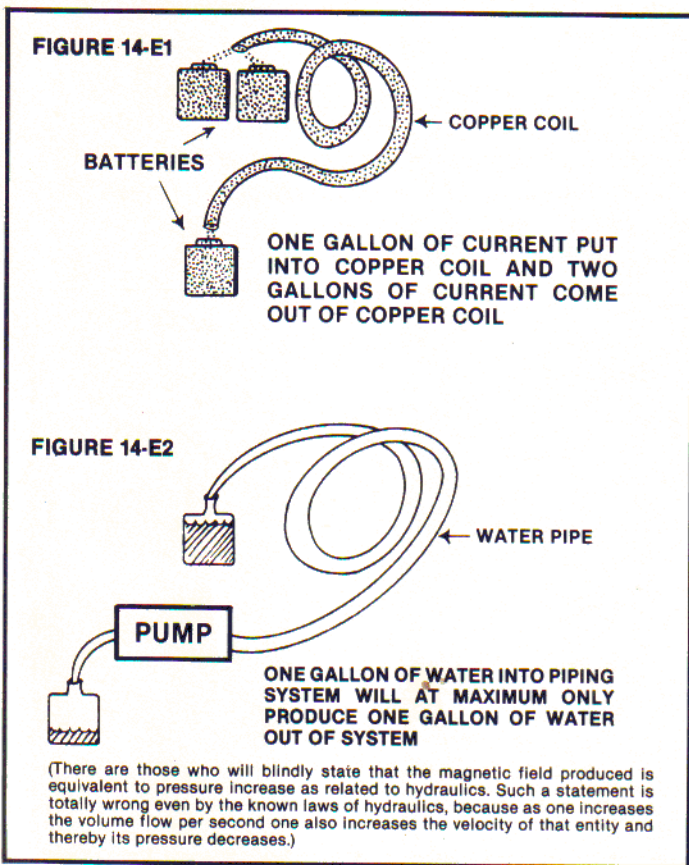

The facts clearly demonstrate that in Figure 14-E1, one “gallon” of current came from the copper coil itself and most definitely *not* from the initial one “gallon” of current put into the copper coil. (This is an analogy only. The mass or volume of the electric current input or output cannot be seen or weighed because it is composed of gyroscopic particles and is the mechanical essence of $E = MC^2$.)

¹⁴ F. The Prior Teachings distort the above facts and would indicate that the analogy of one “gallon” of current has no pressure when coming from the coil in Figure 14-E1, and that one “gallon” of current has a pressure which is thereby equivalent to one “gallon” of current with the input pressure. Furthermore, such teachings would indicate that because of the resistance within the coil and other losses, not even the latter pressure will occur in reality.

Even I was misled by these teachings for many years, and I finally came to the realization that copper was highly magnetic by a completely different means than outlined above. These means included: (1) my general comprehension which originated with my recognition that the basic building block of *all* matter was the *gyroscopic particle*, and (2) a test I conducted using a single piece of copper wire 800 feet long, which was doubled-back 400 feet to the

starting point and hooked to a meter and dry cell battery. (See Figures 14-F1 and 14-F2.)

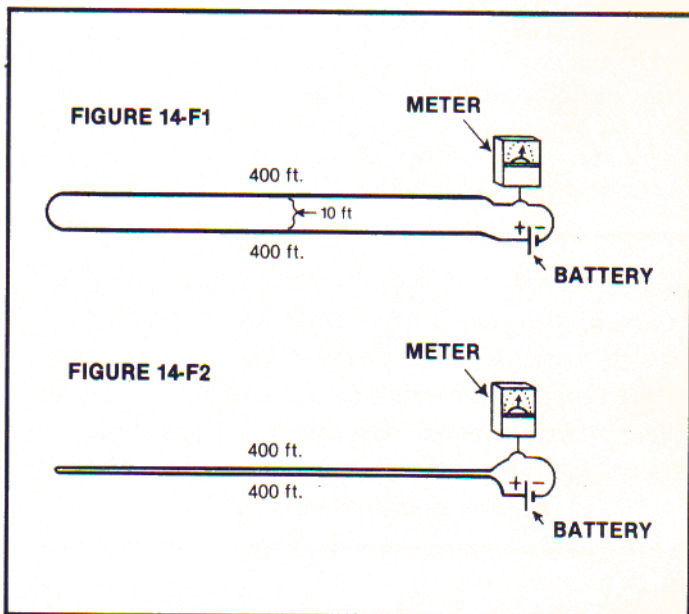

The test shown in Figure 14-F1 has the parallel positions of the wire 10 feet apart, with no “Unobvious Force” between the parallel portions of the wire. The test shown in Figure 14-F2 has the parallel portions of the wire extremely close, with an “Unobvious Force” between the parallel parts of the single wire.

The results of these two tests demonstrated the *same* current input for both tests. Prior to these results I had recognized that the words “Work,” “Force,” and “Power” are implicit engineering statements and do not represent precise, scientific terms based upon observational reality. I conceptually altered such macroscopic, engineering statements to “Obvious work,” “Obvious Force,” and “Obvious Power.” I would microscopically describe what occurs internally, within matter as “Unobvious Work,” “Unobvious Force,” and “Unobvious Power.” (I will explain these concepts later in this Book.) Such semantic clarification enabled me to know — upon completing the above tests in Figures 14-F1 and 14-F2 — that copper is extremely magnetic.

¹⁴ G. Returning to the above test of Figure 14-E1 and 14-E2: by my teaching, the facts clearly show that in the above analogy, one gallon of current “matter” (consisting of gyroscopic particles) was released from the atoms of the copper coil! This extra one gallon of current (gyroscopic particles) comes from the component parts of the atoms comprising the copper coil and simply utilizes Einstein’s Equation of $E = MC^2$. (I must stress that this is an analogy only. The volume or mass of matter via the gyroscopic particles represents the mechanics of $E = MC^2$ and such particles cannot be seen or weighed by conventional means. Their existence can be inferred, however, based on their mechanical behavior combined with known, observational facts.)

QUESTION: How can this *extra* one gallon of current exist?

ANSWER: The current input (gyroscopic particles) simply *acts as a catalyst* relative to the atoms comprising the copper coil — atoms which align and unalign extremely fast compared to the atoms of conventional, magnetic materials — thereby releasing virtually immeasurable portions of the gyroscopic particles comprising the atoms of the coil. This release generates the magnetic field. When the input current is turned off, the collapsing (gyroscopic particles of the) magnetic field within the coil results in the gyroscopic particles attempting to return to the atoms from which they initially emanated. Such mechanical action results in the gyroscopic particles striking other atoms within the copper coil at some degree of a right angle and moving *at right angles to that force*. This gyroscopic mo-

“Such mechanical action results in the gyroscopic particles striking other atoms within the copper coil at some degree of a right angle and moving at right angles to that force.”

tion explains the source for the additional “one gallon” of current (gyroscopic particles) discussed in the above water analogy. Because of the “conversion efficiency” of this process via $E = MC^2$, there will be *no* observable change in the mass of the copper coil even after decades of use.

I should add that there is an important conceptual distinction between two meanings of the word “efficiency.” To state that a given invention is 8.2 efficient, *i.e.*, it produces over eight times as much energy as it consumes, is different from stating that the invention is 100 percent efficient, *i.e.*, it completely converts the gyroscopic particles within the magnet from “magnet mass” to electrical energy. The former process involves *production* efficiency and the latter process involves *conversion* efficiency.

15. Now to discuss the practical usage for this new understanding of the gyroscopic particles which are the mechanical essence of the equation $E = MC^2$ and comprise the component parts of the atoms within all matter, conductors, and copper. By understanding the teachings (of this Pioneering Invention), one can build a physical embodiment of this Pioneering Invention by using a conducting coil which will produce more energy out of the system than that put into the system from an outside source such as battery, generator, etc.

I wish to thank Dr. Roger Hastings, Senior Physicist for Sperry-Univac, for calculating by conventional mathematics the quantitative measurements for the following test which I had proposed. Dr. Hastings is an exceptional scientist who had the character to come forth in my behalf when many others were fearful or close-minded.

For “mind-opening purposes” (to use the current vernacular) carefully study the following two tests:

15

A. Take 40-gauge copper wire which has a resistance of 1,049 Ohms for 1000 feet with a total weight (of atoms composed of gyroscopic particles) of a mere .02993 lbs., turning same into a coil with a 10-foot interior diameter and 8.32 feet in height. One would therefore have approximately a mere 31.8 turns of copper wire (copper atoms, *i.e.*, gyroscopic particles). (See Figure 15-A.)

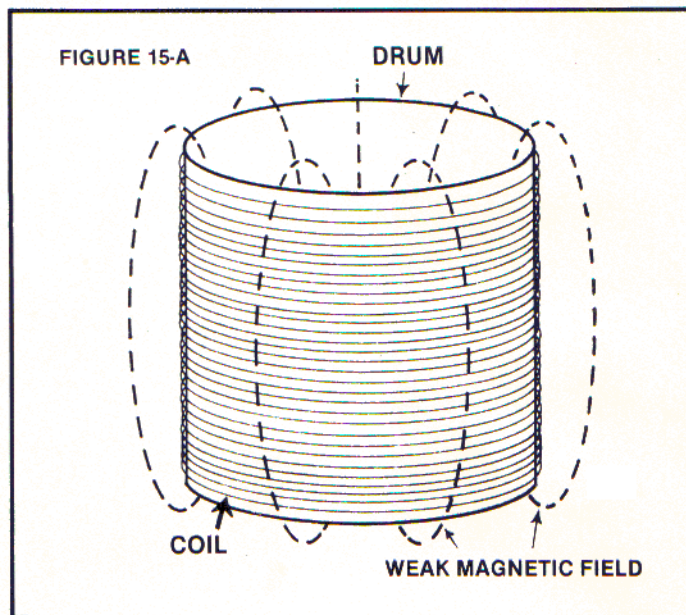

If 100 volts is connected to coil 15-A, then a current flow of approximately 95MA would occur with total power input of 9.5 watts and a resulting weak, magnetic field of .012 Gauss or a mere .000014 Joules of energy stored in this weak, magnetic field.

An insignificant current flow would now occur if the current input was stopped and coil 15-A was shorted-out to collapse a weak magnetic field and provide an inductance of only .003 Henries.

15

B. Now, conduct another test with 5-gauge copper wire which has a resistance of .3133 Ohms for 1000 feet. However, to equal the same resistance as in 15-A above, one must now use 3,348,000 feet of 5-gauge wire with a massive, total weight (of atoms composed of gyroscopic particles moving and traveling at the speed of light, *i.e.*, the mechanical essence of Einstein's Equation $E = MC^2$) of 335,469.6 lbs. or 16.77 tons. Such wire is turned into a coil with a 10-foot interior diameter and 8.32-foot height. This structure would have approximately a phenomenal 90,000 turns of 5-gauge (copper atoms). If 100 volts were now connected to coil 15-B (see drawing below), then a current flow of approximately 95MA could occur with a total power input of 9.5 watts and a resulting, phenomenally larger magnetic field of 23.7 Gauss, or 1,905 times larger for coil 15-B than for coil 15-A, and 116 Joules of energy stored in the magnetic field of Figure 15-B below. This represents a phenomenal 8 million times more energy than in the 40-gauge coil of 15-A above.

PHENOMENALLY STRONGER MAGNETIC FIELD

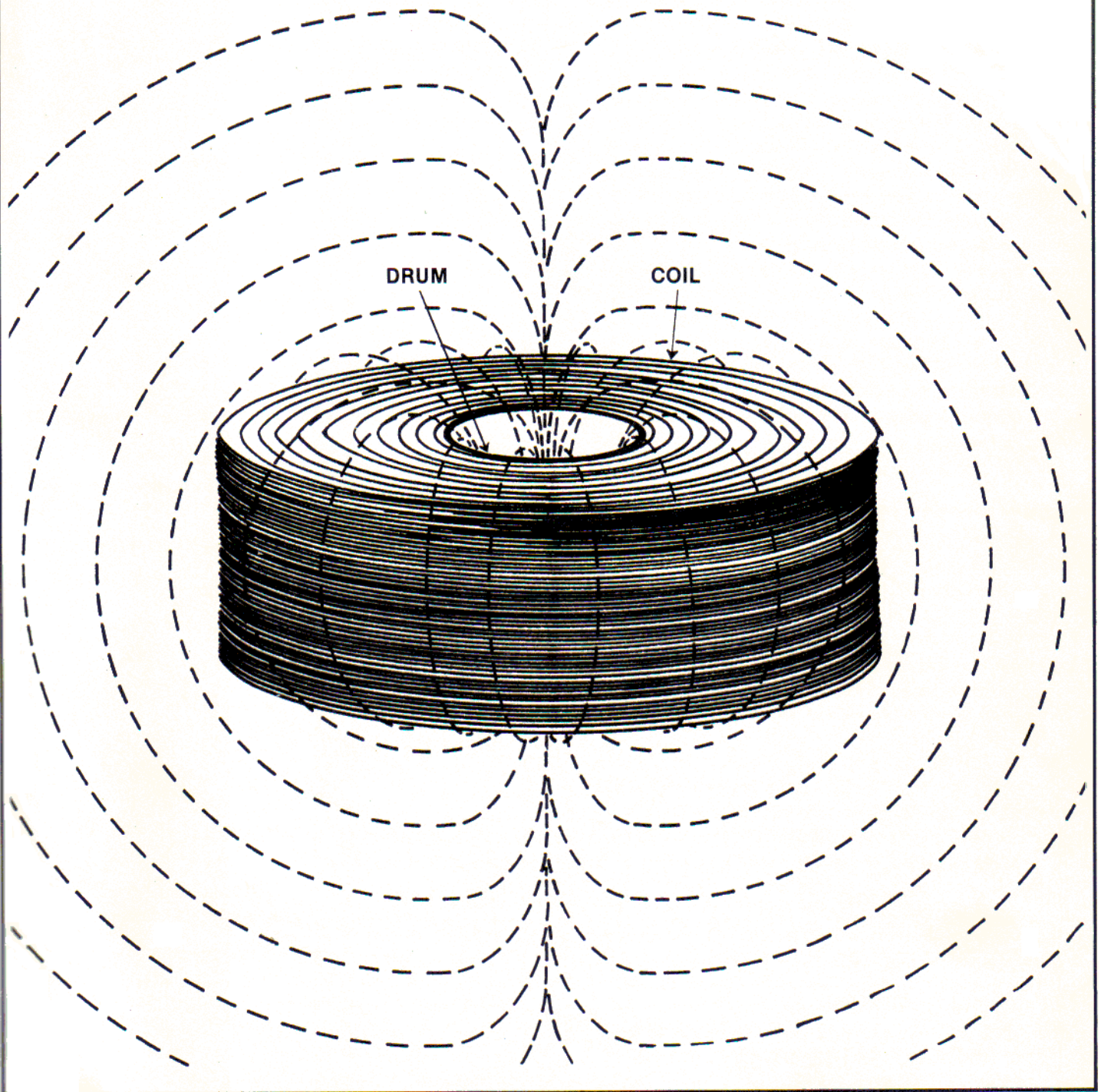

A phenomenally larger current flow would now occur if the current input was stopped and coil 15-B was shorted-out as a result of the collapsing, much greater magnetic field of the 5-gauge wire in coil 15-B. Such shorting would generate an inductance of 25,700 **Henries**, which is better than *8 million times the inductance of the 40-gauge coil in Figure 15-A above.*

Clearly, these facts — combined with the above FACTS 1 through 14 — prove beyond any doubt that Oersted's conclusion in 1820 (which is still taught to

this day): "that the magnetic field came only from the current and not the conductor" to be totally false. [Although his conclusion is incorrect, I remain grateful to Hans Christian Oersted for being the first to notice and attempt to explain an observed connection between an electric current and a magnetic field.]

When coupled with FACTS 1 through 14, tests 15-A and 15-B clearly prove that the phenomenal difference in strength for the resulting magnetic fields (implying great differences in stored energy) and additional current flow when the input current was stopped (induc-

tance), had to come from the gyroscopic particles comprising the component parts of the atoms within the copper coil.

*The current flow input was the same in both tests, but the number of atoms (lbs. of copper) varied considerably from test 15-A to test 15-B correlating precisely with the phenomenal difference in the strength of magnetic fields produced, the extreme difference in the stored energy (gyroscopic particles), and the great difference (inductance) in the additional current flow produced when the input current was stopped in test 15-A and test 15-B. These phenomenal differences represent the mechanical essence of $E = MC^2$: **gyroscopic particles.***

All of the above FACTS 1 through 15 scientifically establish the position that the mathematical formulas employed in the calculation of the energy within a magnetic field (intended to represent the potential energy or stored energy of Joules in a magnetic field) are totally incorrect. The FACTS above clearly indicate that the magnetic field consists of *gyroscopic-type particles* which are the mechanical essence of $E = MC^2$ and represent an orderly flow of kinetic energy.

I will go further and state that "potential" energy, as such, does not exist! All energy is *kinetic* in nature, since the gyroscopic particles continue, under all conditions, to move and spin at the speed of light in accordance with $E = MC^2$.

The above FACTS prove beyond question that the proper mathematical equation (concerning the "kinetic" energy which makes up a magnetic field) must be relative to $E = MC^2$. A proper mathematical equation would recognize that the "Unobvious Force" produced represents the Joules of the "Unobvious Power" activated at that instant-in-time and as so used would diminish the mass of the source of the

Maxwell explicitly stated his debt to Faraday:

*"The methods are generally those suggested by the processes of reasoning which are found in the researches of Faraday, and which, though they have been interpreted mathematically by Prof. Thomson and others, are very generally supposed to be on an indefinite and unmathematical character, when compared with those employed by the professed mathematicians. By the method which I adopt, I hope to render it evident that I am not attempting to establish any physical theory of a science in which I have hardly made a single experiment, and that the limit of my design is to shew how, by a strict application of the ideas and methods of Faraday, the connexion of the very different orders of phenomena which he has discovered may be clearly placed before the mathematical mind."**

15

C. In 1979, I filed a patent for this Pioneering Invention of which several embodiments have been taught and disclosed since that time. The use of a conducting coil is one of those embodiments and the original patent and continuing patent applications were filed before *any* physical prototypes based on the Theory were built. The physical prototypes were thereafter built for the benefit of others, not for myself, since I knew such prototypes would operate as I had predicted. Scientifically, one should find pertinent the fact that when these prototypes were constructed, they performed *exactly* as I had conceptually predicted in the patent applications for this Pioneering Invention.

See below picture 15-C1 featuring one of these early prototypes utilizing 5-gauge, insulated copper wire with a total weight of approximately 4,200 lbs. of copper atoms (or over two tons), 300 lbs. of No. 30

"... the magnetic field consists of gyroscopic-type particles which are the mechanical essence of $E = MC^2$ and represent an orderly flow of kinetic energy."

magnetic field via a 100% utilization (*conversion efficiency*) of Einstein's Equation $E = MC^2$, since the magnetic field consists of kinetic energy having a gyroscopic action which represents the mechanical essence of $E = MC^2$.

I leave the task of determining the nature of such equations to a thinking, questioning mathematical mind, as I do not have the mathematical expertise. It should be noted, however, that the mechanical comprehension of a natural phenomenon has often historically preceded a mathematical model. James Clerk Maxwell acknowledged the importance of Michael Faraday's mechanical and experimental abilities. Maxwell also recognized that such mechanical aptitude constituted a major intellectual input to his later mathematical theories. In his paper 'On Faraday's Lines of Force,' read before the Cambridge Philosophical Society on December 10, 1855 and February 11, 1856,

Gauge copper wire (atoms) wrapped over the outside of the 5-gauge wire (atoms), and a permanent magnet containing approximately 600 lbs. of atoms (or slightly less than $\frac{1}{2}$ of a ton). [I am deliberately referring to the wire as "atoms" and describing the magnet as 600 lbs. of "atoms" in order to accustom the reader to a mechanical perspective concerning the nature of the action of the gyroscopic particles contained within all atoms.]

The massive, permanent magnet had an approximate 20-inch diameter and was slightly less than 4 feet long. The large, conducting copper coil had an approximate 1.D of 4 feet, was approximately 3 feet in height, and was wrapped upon a large fiberglass tube. The total weight of the system was approximately 5,000 lbs.

*L. Pearce Williams, *Michael Faraday*, Chapman and Hall, Ltd. London, 1965, pages 510-511.



PHOTO 15-C1 (SIDE VIEW)

PHOTO BY MATT ANDERSON



PHOTO 15-C1 (TOP VIEW)

PHOTO BY MATT ANDERSON

The photographs shown in 15-C1 simply represent a primitive, handmade prototype made (in the backwoods of Lucedale, Mississippi, by me and my lovely, devoted wife) to prove to others that the Technical (Theoretical) Process which I originally developed and taught is correct. I consider the Technical Process to be 10,000 times more important than the primitive, working prototypes.

With only 1½ watts input, the back power (emf) produced would generate a spark at the commutator of such heat magnitude that the back power would, in a short period of time, explode and destroy a ceramic insulator from a 5-watt resistor placed on the commutator at the point of current reversal. Dr. Roger Hastings estimated the back emf to be in excess of 80,000 watts.

The rotating, handmade, 600 lb. (of atoms), 4-foot magnet permitted a slow RPM. At 200 RPM it was calculated by others that the centrifugal force would be 10,000 lbs. of force attempting to pull the magnet apart.

Everyone who initially viewed the massive unit in 15-C1 above was then asked the question: "Based on your expertise, how much power would be necessary to simply operate this device mechanically?" Answer: from 200 to 1000 watts. Other skilled individuals — upon learning that the unit had only copper in the coil — stated that in their expert opinion, the unit would be highly inefficient since it contained no iron core.

However, the facts pertaining to the unit's operation in 15-C1 do clearly prove that the unit could operate on *less than 1½ watts and that it was phenomenally efficient, i.e., far in excess of 100% production efficiency relative to the power out of the system compared to the external power into the system, and exactly 100% conversion efficiency relative to the conversion of the mass (gyroscopic particles) of copper atoms to electrical and rotational energy output.*

I must stress that this process is not "perpetual motion." Anyone who follows my teachings is simply

"The energy out of the total system is equivalent to the small amount of electrical energy input (acting as a pure catalyst) plus the extant magnetic energy (in the form of gyroscopic particles) within the system."

converting (on a 100% conversion efficiency basis) mass into energy via a 100% (or more) production efficiency process. Therefore, the energy out of the total system is equivalent to the small amount of electrical energy input (acting as a pure catalyst) plus the extant magnetic energy (in the form of gyroscopic particles) within the system. Due to this latter combination of energies, it may be said that the external energy output is greater than the external energy input.

I will again turn to Dr. Roger Hastings (Senior Physicist with Sperry-Univac) who has conducted more tests on different occasions upon my working prototypes than anyone else. I reemphasize the point that Dr. Hastings is an exceptional scientist who has courage and the true scientific attitude. As a result, he came forth in my behalf when many others were frightened or closeminded.

The verification of the operation of the unit in 15-C1 above, as well as other prototypes, and the qualitative scientific ability and fortitude of Dr. Hastings are clearly demonstrated via the test described in Chapter Five. Such a healthy, scientific attitude is even more exemplified by the fact that Dr. Hastings went on record as having once had the attitude that, before he traveled to Lucedale to meet me, to listen to my concepts, and to conduct tests, he was of the belief that he would be confronting a "crack-pot inventor." Fortunately, Dr. Hastings' skepticism was tempered with genuine curiosity. I have discovered that without such curiosity, skepticism will rapidly decay into cynicism.

Dr. Roger Hastings' statements and tests follow.

Chapter 5

DECLARATION BY DR. ROGER HASTINGS

FOLLOWING EXTENSIVE TESTING ON 5,000 AND 900 LB. UNITS

DECLARATION

The Honorable Commissioner
of Patents and Trademarks
Washington, D. C. 20231

Gentlemen:

This letter represents a disclosure of investigations and experimentation which I have performed on Mr. Joseph Newman's energy generating machine (patent pending). The fact is that every experiment which I have performed shows that the energy output of the device is indeed larger than the energy input. Some examples are:

1.) The electrical energy output is measured at more than four times the electrical energy input. These results may be verified by examining the oscillograph records taken by Dr. F. Neff Weber in December, 1981.

2.) Acting as a motor Mr. Newman's device performed mechanical work in excess of ten times the electrical energy input.

3.) Mr. Newman's device delivers over ten times the torque of a commercial D.C. permanent magnet motor rated at 80% efficiency. However, during this test Mr. Newman's device is consuming only a fraction of the input power of the commercial motor.

These results must be taken seriously. Mr. Newman has made the observation that huge magnetic fields may be generated with minimal power input in a large coil wound with large diameter wire. This coil creates a very large torque on a suitably large permanent magnet. In operation, the batteries powering the coil consume little power and discharge at a very slow rate. Yet the motor delivers considerable mechanical and/or electrically generated power.

It is fascinating to observe that Mr. Newman has arrived at this invention on the basis of his theoretical work, coupled with years of experimentation on electromagnetic energy. The fact that Mr. Newman is self-taught, with no formal training in advanced mathematics or physics, is apparent in his writings. Yet he has been rigorously consistent in development of a model of matter and energy, and furthermore has fortified his model with experimentation. His model is based on the assumption that matter is concentrated electromagnetic energy. He predicts that this energy ($E=MC^2$) may be released in a controlled way, and his experiments verify the prediction.

In view of the benefit Mr. Newman's device could bring to mankind, I urge you to take his patent application seriously, and not to be prejudiced by the style or claims of his writings. The patent application is in order and the stated results have been verified by experts. The burden is now upon you to act, either by issuing the patent immediately, or by first conducting your own measurements on his device to verify the claim.

The future of the human race may be dramatically uplifted by the large scale commercial development of this invention. It is indeed painful to see it lying dormant.

In hope that you will act soon,

Yours sincerely,

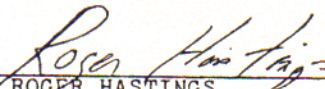
DR. ROGER HASTINGS
Principal Physicist
Sperry Univac Corporation
Former Associate Professor of Physics
North Dakota State University
Author of Scientific Literature

Waiver: I am acting on my own,
and am in no way representing
Sperry Univac Corporation.

DR. ROGER HASTINGS

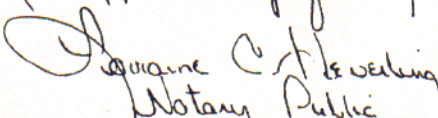
Subscribed and sworn to
February 21, 1982 State of
Mississippi, County of Hodge

Joanne C. H. Leavelle
Notary Public
My Comm.

April 26, 1982

A PERFORMANCE ANALYSIS OF THE NEWMAN MOTOR

This document compiles and analyzes the results of several experiments performed on the Newman Motor in 1981 and 82. The results of the experimental work show that this motor operates with energy output far in excess of energy input. This work is intended to characterize the motor, and to organize the experimental results. It is hoped that the document will serve as a guide in the development of the mathematical theory which explains the Newman Motor.

I. Mechanical Energy Output

A.) Test against a d.c. Permanent Magnet Motor/Rated 80% Efficient.

Date: 2-20-82

In this experiment eight fresh 1.5 Volt alkaline batteries were connected to an 80% rated efficient d.c. motor. The motor turned an oil pump at about 1 Hz. The motor ran for 6 minutes, and the final battery voltage was about 60% of the starting voltage.

Alkaline batteries were used because battery performance curves were available from the manufacturer. One such chart is plotted in Fig. 1. The performance of the d.c. motor is verified by the chart, which predicts that the batteries, when initially drained at 2 amps, will last 6 min. The measured motor drain under load was near 2 amps.

The above results allow us to estimate the power consumed by the oil pump. We find:

$$\frac{\text{initial pump output power}}{\text{initial battery input power}} = 0.8$$

$$\text{pump output} = 0.8 \times 2 \text{ amps} \times 12 \text{ volts} = 19 \text{ Watts}$$

The same pump was connected to the Newman Motor (with a 90# permanent magnet rotor) so that the pump again ran at near 1 Hz. Therefore, the pump was consuming the same power in this experiment. Eight fresh batteries were connected to the Newman Motor. (Unit designed as instructed in Patent Application, Serial No. 179,474, illustrated in Fig. 6 and stated in 1st three paragraphs of page 3 of Declaration by Joseph Westley Newman of September 19, 1981.) The batteries

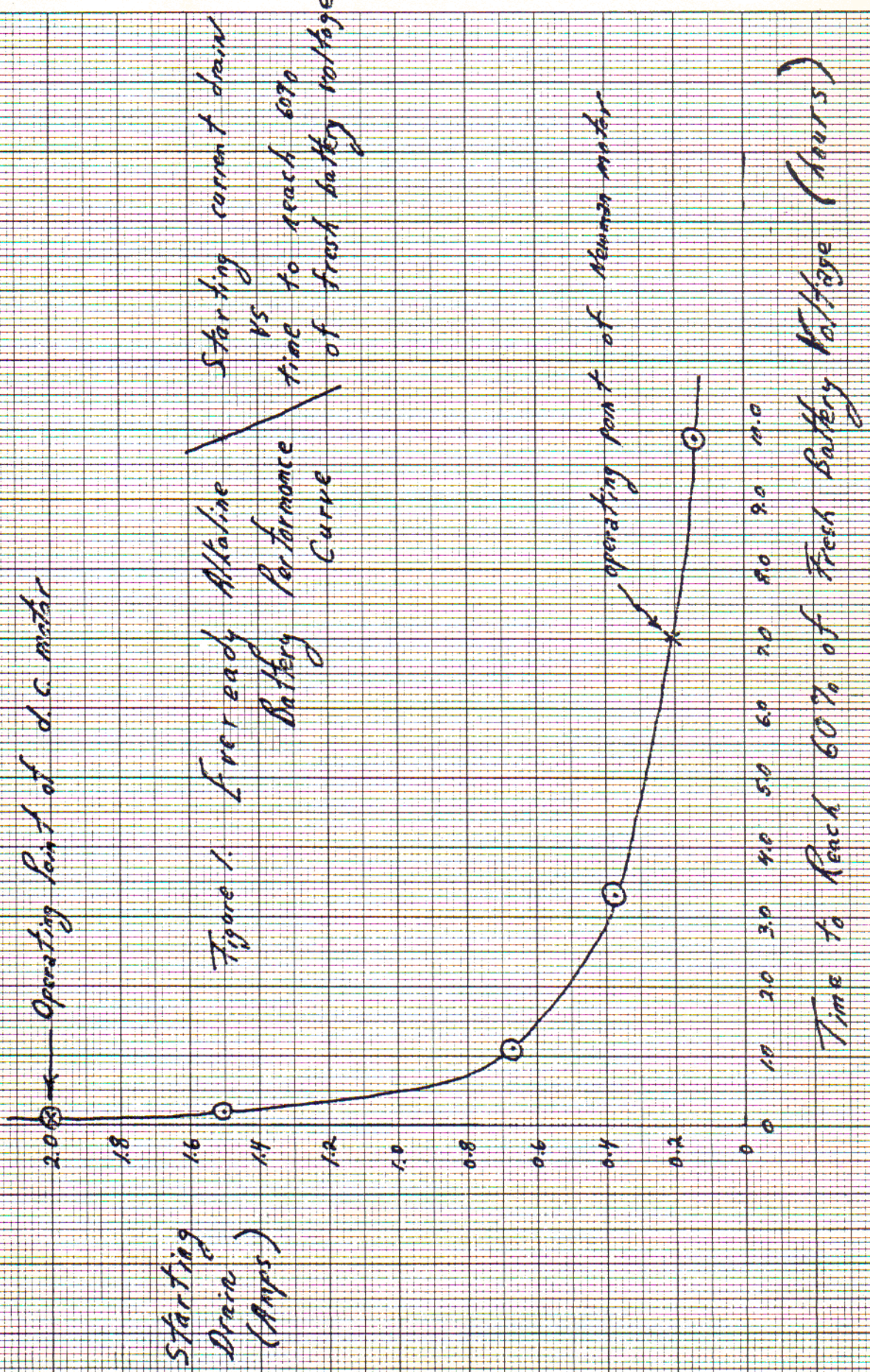

were drained to about 60% of their starting voltage after seven (7) hours! Although the input current to the Newman Motor follows a complicated waveform, we may estimate the initial average input current from the performance curve (fig. 1). Using 0.2 amps at 12 volts we find:

Initial Newman Motor Input = 2.4 Watts

Since the output is consuming 19 Watts we have:

$$\text{Newman Motor Efficiency} = \frac{19}{2.4} \times 100\% = 800\%$$

At this point we note that the intrinsic efficiency of the Newman Motor could be greatly increased. As designed now the motor has a tremendous leakage flux, and extreme mechanical losses. An efficiently designed Newman Motor would certainly have three times the efficiency quoted above, and perhaps ten times (8000%!).

B.) Static Torque Test

Date: 2-20-82

The output shafts of the d.c. motor and Newman Motor were connected in turn to a scale via a pulley and belt. The d.c. motor pulled a maximum of 1.5 lbs., while the Newman motor pulled 13 lbs. At maximum load the d.c. motor consumed about 24 Watts while the Newman Motor consumed only 2.4 Watts.

$$\text{Static Torque Ratio} \quad \frac{\text{Newman motor}}{\text{d.c. motor}} = \frac{13}{1.5} = 8.7$$

$$\text{@ input energy ratio} \quad \frac{\text{Newman Power}}{\text{d.c. motor power}} = 0.1$$

If we define a motor performance parameter under static loads by the ratio of maximum torque output to the input energy drain, we find that this number is 87 times larger for the Newman motor than for the d.c. permanent magnet motor!

C.) Battery Lifetime Tests

March/April, 1982

It has become apparent that the batteries powering the Newman motor outlive the expectations of the manufacturer. In this test 124 old alkaline batteries were used to power the (90 lb. rotor) motor. The batteries read 2/3 of their fresh voltage value at the outset of the experiment. It was found that the 90 lb. cylindrical

rotor is spun up to 6 Hz. in 21 sec. when the batteries are connected to the motor. The voltage drops from 125 V. to 70 V. when the batteries are connected, and remains at 70 V. when the rotor runs at speed. The minimum power supplied by the batteries is therefore equal to the power required to spin up the rotor.

This is:

$$P = \frac{1}{2} I W^2 / t$$

where t = time to spin up rotor = 21 sec.

W = angular speed = $2 \times \pi \times 6$ Hz.

$$I = M \left(\frac{R^2}{4} + \frac{L^2}{12} \right)$$

M = rotor mass = 41 kg.

R = rotor radius \approx .08m.

L = rotor length \approx .31 m.

This yields a minimum energy required to keep the rotor spinning at 6 Hz. of 13 Watts. Therefore the batteries must be supplying at least $13/70 = 190$ m amps. As a separate estimate it was found that a constant drain of 300 m amps. through a resistor drops the battery voltage from 125 V to 70 V. Consulting the battery charts we find that a fresh battery with a starting drain of 150 m amps. (100 m amps. when $V = 2/3$ starting voltage) will drop from $2/3$ to $1/2$ of its starting voltage in a few hours. If the batteries began at $2/3$ of their fresh voltage under a drain of 250 m amps. they would be very dead in two hours.

The Newman motor has been run for between one and four hours per day for a total of ten hours. The batteries began at $2/3$ of their fresh voltage, and after the ten hours the voltage had not dropped perceptibly. Mr. Newman intends to continue running the motor a few hours per day to test the limits of his motor. Here again the mechanical energy consumed by the spinning rotor is far in excess of the maximum possible electrical energy which could be supplied by the batteries (according to the charts). An efficiency near 1000% is indicated by the experiment to date.

April 20, 1982. On this date the old batteries have worn down to a point at which they will not even run a 1 1/2 V. small toy motor. Yet when they are connected to the Newman motor, the 90 lb. rotor is spun up to 4.5 Hz. in about 20 seconds!

II. Electrical Energy Output

The Newman motor generates electrical energy by induction. The relevant experiments have been documented elsewhere, and indicate an efficiency of about 400% in the generation of electrical power. Experiments have since been run in which mechanical energy was measured via measurement of the frequency at which the motor runs while delivering a measured torque. Electrical energy was simultaneously generated, and the sum of electrical and mechanical energy was roughly twice the energy obtained when only electrical energy was generated. In this experiment an accurate measure of the input power was not made. Instead, batteries were used and the time required to drain the batteries to a given voltage was measured. It was hoped that the battery charts could be used to estimate the input power. The result was too close to 100% efficiency to rely upon the accuracy of the charts. It should be noted that the measured output energy did not include losses in the belt used to transmit torque. In addition, the whole measurement apparatus was set into motion by the magnetic force during rotation.

III. Static Measurements

Mr. Newman has made measurements of the static torque generated by his 600# magnet at various voltages. These results agree with theoretical predictions based upon measurements of the magnetic moment of the magnet. The predicted torque is:

$$\vec{\tau} = \vec{M} \times \vec{H},$$

and the maximum torque is MH . The static field generated by the coil is:

$$H = \frac{N I}{L}$$

$$N = \# \text{ turns}$$

$$L = \text{coil height}$$

$$I = \text{coil current}$$

(Unit also designed as instructed in Patent Application, Serial No. 179,474, illustrated in Fig. 6, and described in Exhibit A of Declaration by Joseph Westley Newman, September 19, 1981, except Magnet Rotary weighed approximately 400 pounds at that time.)

The magnetic field of the 600# magnet was measured at various distances from the magnet using a Hall effect transducer (factory calibrated). These results were compared with the expression for the dipole field to yield a magnetic moment of $M = 10^7 \text{ } \gamma\text{-ft}^3$ or 100 gauss ft^3 . Therefore the maximum torque is predicted to be:

$$\gamma = MH = 2.6 \times 10^{-3} \frac{(NI)}{L} \text{ ft. lbs.},$$

τ in amps,

L in meters.

The length of the motor coil is .69 m. and the number of turns is 2,630. Therefore

$$\gamma = 9.9 I \text{ ft. lbs. (I in amps).}$$

Mr. Newman's measurements of torque and current are listed below:

Voltage	I	γ	γ/I
6	.6	17.3/4	7.21
12	.98	33/4	8.42
18	.75	29.3/4	9.77
24	1.3	38/4	7.31
30	1.4	47/4	8.39

average 8.2

The value 8.2 for γ/I compares well with the predicted value of 9.9 considering inaccuracies in measuring devices.

It has often been noted by Mr. Newman that for a fixed power input to a coil, the torque increases with the moment of the magnet. If the magnet is made infinitely magnetic the torque becomes infinite, even if the power to the coil is very small.

IV. Dynamic Properties

A.) Inductance

To begin with, the inductance of the 600# magnet motor coil may be predicted and taken from measurement. The predicted value is:

$$L = \mu_0 N^2 \frac{A}{L},$$

A = coil area

L = coil length

N = 2630

With a coil radius of 2.5 feet and 2.25 feet length we predict
L = 23 henries.

In operation the motor inputs a square wave voltage for a fraction of the roughly 0.5 Hz. cycle. Since the coil resistance is 13 Ω , L/R should be much larger than one period, and we predict a current rise of:

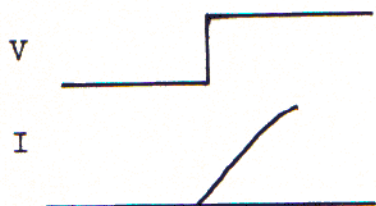

$$I = \frac{V}{R} (1 - e^{-t/L/R}) \approx \frac{V}{L} t$$

From an oscillograph photo with no load on the system, the coil current rises 0.5 amps in 0.1 sec. when 200 volts are switched across the coil. Thus:

$$L = \frac{200 (0.1)}{0.5} = 40 \text{ Henries}$$

The magnet is turning during this measurement so the approximate agreement between theory and measurement is reasonable.

B.) Motor Frequency

Under no load and assuming zero friction, the maximum theoretically possible frequency of the motor is determined by the condition that the induced voltage is equal to (-) the input voltage. The induced voltage is:

$$V_{ind} \approx -\omega B_{magnet} \pi R_o^2 N ,$$

B_{mag} = magnetic induction of rotating magnet

R_o = coil radius

ω = 2π x frequency

With $V_{ind} = -V$ we find:

$$f = \frac{V}{2\pi \pi R_o^2 N B_{mag}}$$

$$\text{Now } B_{mag} = 2\pi \frac{M}{\kappa} ,$$

M = magnetic moment, κ = magnet volume

With $m = .01 \frac{W}{m^2} (ft)^3$, $R_o = .76 m$, $N = 2630$,

$$\pi = \pi (1')^2 \times 4' = 12.56 (ft)^3 \text{ we find:}$$

$$f = \frac{V}{4\pi^3} \frac{\sqrt{L}}{M N R_o^2} = .0067 V (Hz)$$

$$f = .402 V (rpm)$$

At 200 Volts we find the maximum frequency, if the motor had a 100% intrinsic efficiency (no losses), is :

$f = 80.4 rpm$, about double the 600# observed motor frequency under no load.

C.) Energy Input (Theoretical Estimate)

Assuming that:

- 1.) The voltage input and induced emf are 180° out of phase.
- 2.) The voltage input varies sinusoidally.

We have:

$$(V - V_{ind}) e^{i\omega t} = L \frac{dI}{dt} + IR$$

$$I = \frac{V - V_{ind}}{R \sqrt{1 + (\frac{\omega L}{R})^2}} \cos(\omega t - Q)$$

$$\text{where } \tan(Q) = \omega L / R$$

The average power consumed by the coil is then:

$$P = \frac{1}{2} \frac{V (V - V_{ind})}{R \sqrt{1 + (\frac{\omega L}{R})^2}} \cos(Q)$$

$$P = \frac{1}{2} \frac{V (V - V_{ind})}{R (1 + (\frac{\omega L}{R})^2)} \approx \frac{V}{2\omega L} \frac{R}{\omega L} (V - V_{ind})$$

$$\text{With } \omega = 2\pi \frac{40}{60} \approx 4, L = 50, \omega L = 200, \frac{\omega L}{R} = 20$$

$$V = 200 \quad V_{ind} \approx \frac{1}{2} V = 100,$$

$$P = \frac{100}{40} = 2.5 \text{ Watts}$$

This number agrees approximately with Mr. Newman's measurements of input power, in an experiment in which output was measured at about 5 Watts. The numbers used in the above calculation are approximate so the result represents an estimate. The expression for the input power along with the expression for V_{ind} allow a prediction of how input power varies with motor frequency and voltage. The plot is shown in Fig. 2, and the prediction is given below:

$$\text{Predicted Power Input} = \frac{450 \left(\frac{V}{200} \right)^2 \left(1 - \frac{200}{V} \frac{f}{80} \right)}{\left(1 + \left[\frac{f}{3.1} \right]^2 \right)} \quad \text{Watts}$$

V = input voltage (volts)

f = motor frequency (rpm)

This result was obtained by requiring the derived formula to match the experimental result that input power at 200 volts and 35.7 rpm. is 1.8 Watts.

V. Predicted Output Power

The output power is found by averaging the product of torque on the magnet and frequency over one cycle. The torque is given by:

$$\vec{\gamma} = \vec{M} \times \vec{H},$$

$$\text{and } \gamma = MH \cos (wt) = \frac{MNI}{L} \cos (wt),$$

Where the fact that maximum torque occurs in phase with maximum input voltage has been used. The output power is therefore:

$$P(t) = \frac{MN}{L} \frac{(V. - V_{ind})}{R} \frac{W}{\sqrt{1 + \left(\frac{wL}{R} \right)^2}} \cos (wt) \cos (wt-Q),$$

and the average power is:

$$P_{out} = \frac{1}{2} \frac{MN}{L} \frac{(V - V_{ind})}{R} \frac{w}{\left(1 + \left(\frac{wL}{R} \right)^2 \right)}$$

Fig. 2 Predicted Input Power vs. Motor Frequency (600# Unit)

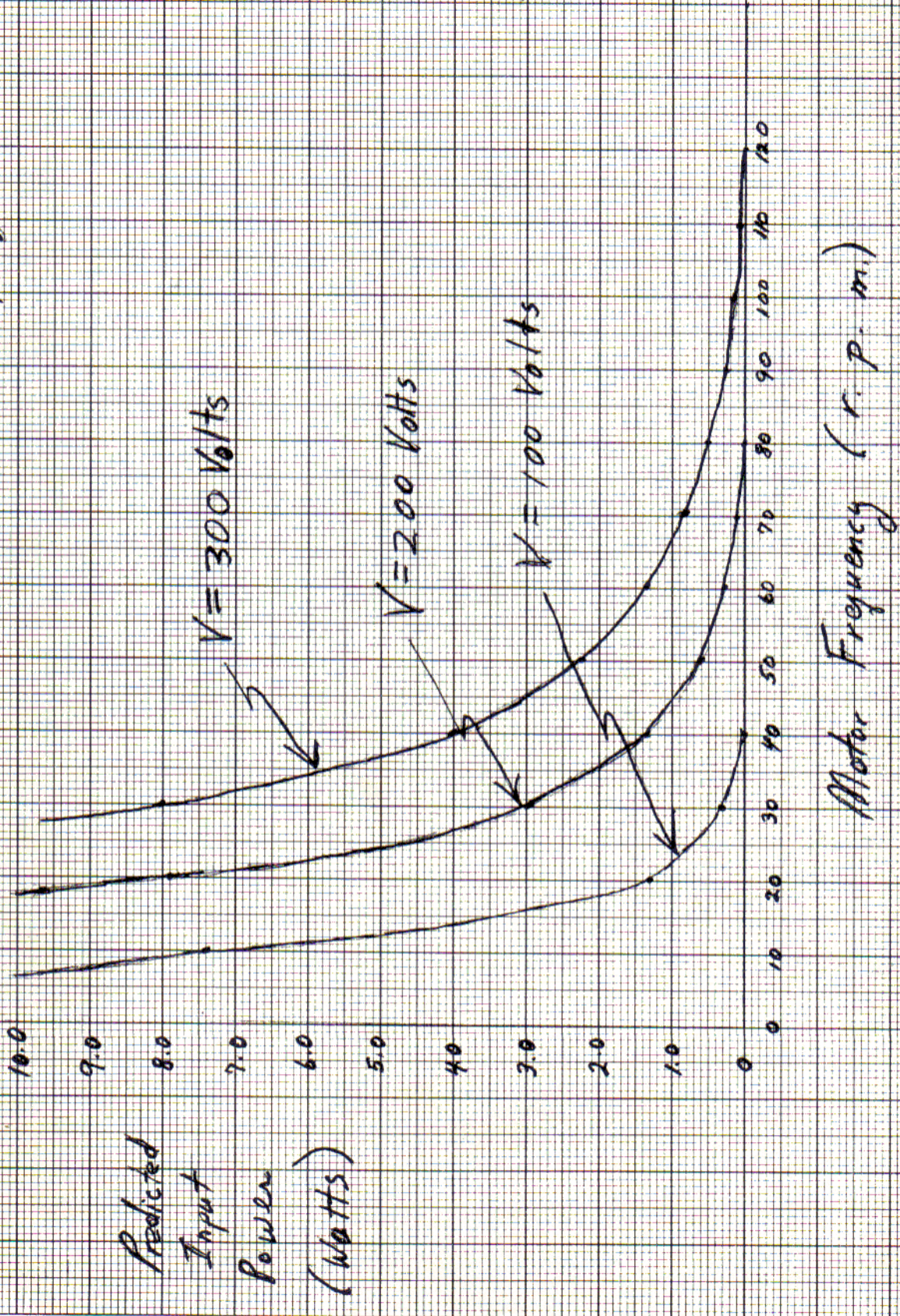

The output power goes to zero at the maximum frequency ($V = V_{ind}$), and also at zero frequency.

VI. Predicted Efficiency

Dividing the expressions for output and input power yields:

$$\text{Predicted efficiency} = \frac{MN}{L} \frac{W}{V} \times 100\%,$$

Where W cannot exceed its maximum value. Using $MN/L = 9.9$ ft. lbs. 1 amp = 13 j./amp yields the following expression for the predicted efficiency of the 600 pound Newman motor:

$$\text{Predicted efficiency} = 1.4 \frac{f}{V} \times 100\%, \quad \begin{array}{l} f \text{ in r.p.m.} \\ V \text{ in volts} \end{array}$$

Operating under no load, the above formula predicts a Newman motor efficiency of 24% (35 rpm at 200 volts). The theoretical maximum motor efficiency is obtained by using the maximum frequency of 80 rpm at 200 V., yielding a 56% upper limit in the case that the motor has zero frictional losses. Working back through the equations it can be seen that the maximum predicted efficiency is given purely in terms of geometrical factors (ratio of magnet volume to coil volume), and cannot exceed 100%.

It is clear that measured efficiencies for the Newman motor are far in excess of predicted efficiencies. The predicted input power is in agreement with measured input.

The measured output power exceeds the predicted output. For example, at 1.8 Watts input and 24% efficiency we expect 0.4 Watts output from the Newman motor. In one experiment the motor generated 5 Watts of output power with 1.8 Watts input drain. The discrepancies are far too large to be explained by experimental errors.

VII. Unusual (Non Conventional) Behavior

As seen above, a number of properties of the Newman motor follow conventional theory. In specific, the input power is as expected. The output power (in excess of input) is the non-conventional result. In my mind the most interesting motor measurement is the oscillograph photos taken around the coil showing very high voltages. This photo also shows the (to me amazing) fact that the coil current is over three times the current at the battery

when the voltage is applied. My opinion is that an excess charge is left in the coil when the input voltage is cut off. At this point a spark appears and a huge induced e.m.f. is created in the coil. This e.m.f. should disappear quickly (showing up as a spike). However, the high voltage remains, having the period of the moving magnet. This indicates that the magnet is "pushing" an excess charge around in the coil, and this appears as excess current when contact is re-established with the battery.

There is also the issue of the "anomalous" current which appears during the spark. It is unclear from the photos whether this current appears in the coil, but it has the proper sign and magnitude to drive the magnet.

VIII. Future Theoretical Research

The upcoming challenge for this writer is to explain the Newman motor output mathematically. The purpose of the above documentation, for me, is to isolate the origin of the excess energy. At that point it is likely that application of a unified theory of charge, matter, and energy, e.g. Mr. Newman's theory, will be required to mathematically describe the results. This mathematical explanation will also have to explain other various embodiments of the Newman Invention, which will obviously result from the Newman Disclosures.

Waiver: I am acting on my own, and am in no way representing Sperry Univac Corporation.

DR. ROGER HASTINGS

DR. ROGER HASTINGS
Principal Physicist
SPERRY UNIVAC CORPORATION
Former Associate Professor of Physics
North Dakota State University
Author of Scientific Literature

Chapter 6

DESCRIPTION OF SMALLER UNIT

WITH AN AFFIDAVIT BY DR. ROGER HASTINGS

The following is a smaller unit (see photograph 15-C2 below) composed of 30-gauge, insulated, copper wire weighing approximately 145 lbs. (atoms) and having a rotating magnet of 14 lbs. (atoms). This portable unit, with very little current input, clearly demonstrates an energy output which is greater than the external energy input. With 300 volts input of pressure, only 1½ milliamps of current (volume of gyroscopic particles) went into the copper coil (of atoms), which is less than ½ watt input for an energy output in excess of 10 watts.

Photograph 15-C2:

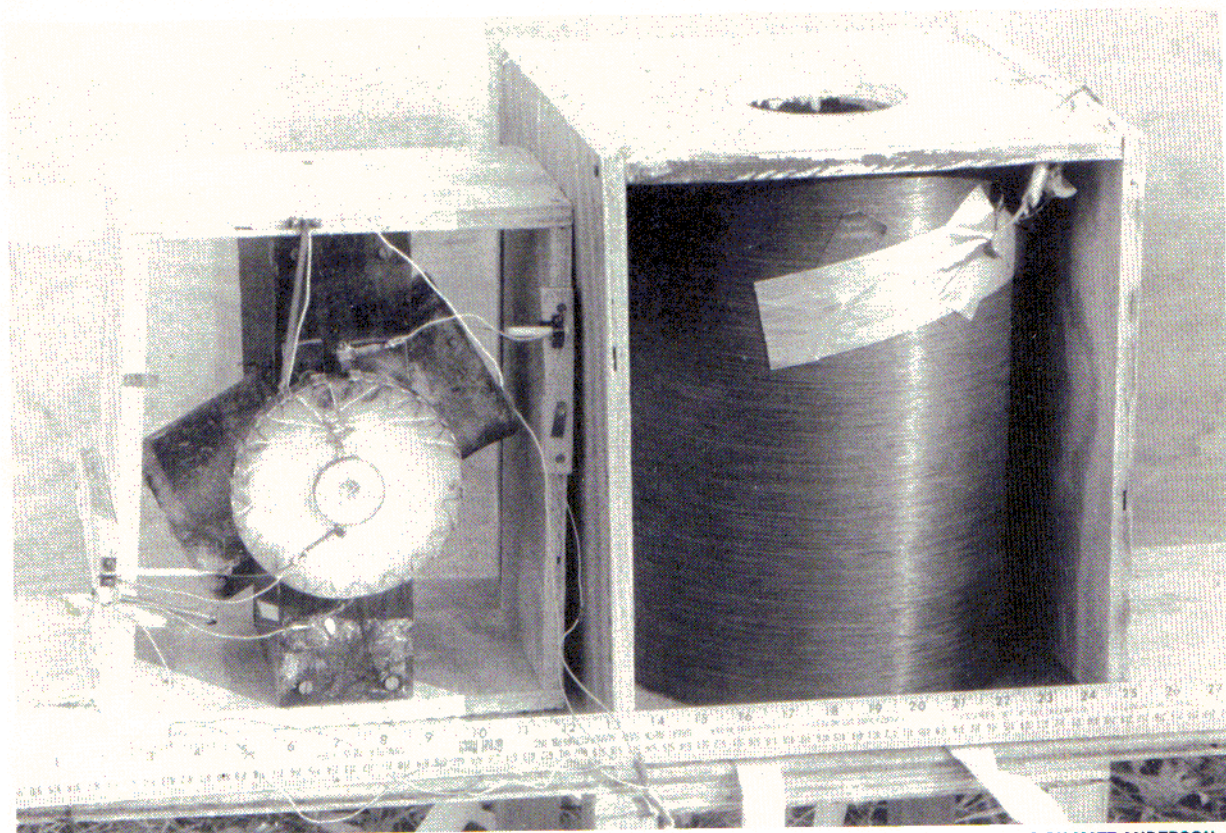

PHOTO BY MATT ANDERSON

See below copy of a test conducted by Dr. Roger Hastings utilizing the 15-C2 unit.

June 17, 1984

TO WHOM IT MAY CONCERN:

On June 16 and 17, 1984 I ran a series of tests on Joseph Newman's 145 lb. motor with 14 lb. rotary. These tests show that power is generated by the motor which greatly exceeds the battery input power. The results are summarized briefly below:

1. Demonstration of Large Current Spikes Produced by the Motor

A. Oscilloscope Readings

The oscilloscope showed large (*1 Amp) staircase current spikes of significant time duration, which were initiated when the commutator switched, and flowed both in the coil and battery portions of the circuit. A picture of this spike taken on the coil side of the commutator is attached. A block diagram of the circuit is shown below.

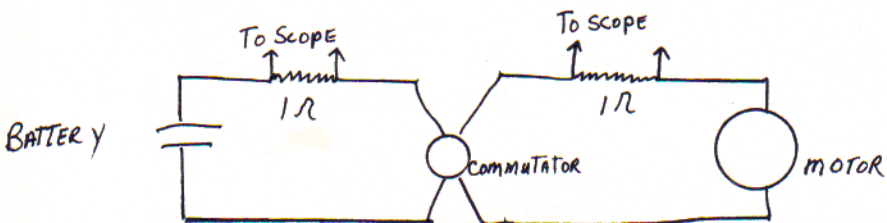
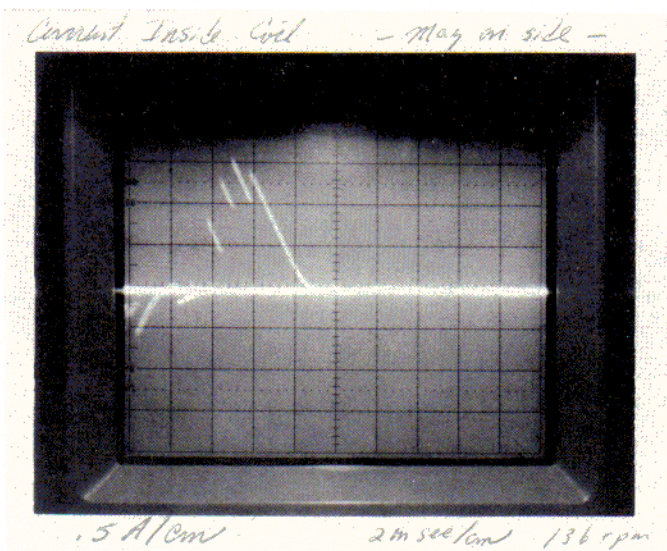

B. Circuit Breaker Tests

An ammeter which has a built in circuit breaker was placed in the circuit. When the meter was placed on the 100 ma scale, the breaker opened, both on the battery and coil side of the commutator.

The breaker did not open when the meter was placed on the one amp scale, however, it was verified that a current input of more than 1.5 times the full scale deflection did not open the breaker.

C. Temperature Rise

A five hundred ohm resistor was placed in series with the battery. The resistor was water-proofed and placed in a small thermos container with a precision thermometer. A temperature rise of approximately one degree Centigrade was observed in a period of fifteen minutes. To raise the temperature of the 21 grams of water by 1 degree in fifteen minutes requires at least an average power of:

$$P = \frac{1 \text{ cal}}{\text{gm}^\circ\text{C}} \times 21 \text{ gm} \times 1^\circ\text{C} \times 4.19 \text{ J/cal}}{15 \text{ min} \times 60 \text{ sec/min}} = 0.1 \text{ Watts}$$

Since the power supplied by the current flowing in the resistor is I^2R , where I is the average current and $R = 500 \Omega$, it follows that a current of at least 14 ma on the average must flow in the circuit. This result was verified experimentally by supplying 14 ma to the 500Ω resistor via a battery and series resistors. If the current contained in the spikes (attached photo) is averaged over the cycle time, the result is consistent with an average current of 14 ma.

2. Demonstration that Large Current Spikes are not Produced by the Battery.

A. Current Readings

When a Simpson amp meter is placed in series with the batteries, a d.c. input current of 1.2 ma is registered. The battery input current is therefore 1.2 ma.

B. Expected Input Current

When the rotor is stopped, the input current from the batteries is measured to be 6 ma (this is in agreement with 304 volts and $50 \text{ K}\Omega$ coil resistance). The coil inductance, as calculated from the number of wire turns and the geometry, is 16,000 Henries. At the operating speed of 136 r.p.m., the inductive reactance of the coil is $230 \text{ K}\Omega$, which is much larger than the coil resistance. The expected battery input current is $304 \text{ V}/230 \text{ K}\Omega = 1.3 \text{ ma}$, in good agreement with the measured input of 1.2 ma.

C. Constant Battery Voltage

During four hours of continuous running of the motor, the voltage remained constant at 304 volts. If the 15 ma average current contained in the spikes came from the batteries, they would drain down significantly in the four hour period. By

draining 14 ma from a fresh 9 volt transistor battery identical to those on the motor it was found that the 14 ma drain causes the voltage to drop by 2% per hour. Thus if the 14 ma were originating at the battery, the battery voltage would drop by 24 volts in four hours. No drop was observed.

D. Larger Current Spikes on Coil Side

The current spikes, as recorded on the scope, were larger on the coil side of the commutator than on the battery side. This indicates that the spikes originate at the coil, with some loss occurring at the commutator.

E. Negative Current

A significant portion of the spike in the battery circuit is negative (opposing the battery voltage). The battery cannot generate such a negative current.

F. Dependence Upon Rotary Position

The intensity of the spikes varies greatly with the placement of the rotary. For example, when the rotor is on the side (outside) of the coil the spikes are large. They virtually disappear when the rotary is placed on top of the coil.

3. Power and Useful Output

A. Output verses Input Power

Since an average of 14 ma flows through the 50 K Ω coil, the heat dissipated in the coil is ten watts. The battery input is 1.2 ma times 304 volts, or 0.36 watts. The heat generated in the coil is 27 times the input power. Note that if the ten watts were delivered by the batteries, they would drain down very quickly. These batteries have been used in frequent demonstrations for long durations by Mr. Newman over the past several months. As mentioned above, four hours of motor operation during these tests did not measureably lower the battery voltage.

B. Useful Output

Mr. Newman placed a 75 Watt, eight foot, flourescent tube across the motor coil, and the bulb lit to perhaps 10% of full brightness. Interestingly, when the bulb was inserted, the rotary gained speed, and the motor drew less current from the batteries! The lit 75 watt tube demonstrates useful output of several watts, with a fractional watt input power.

I swear the above statements are true and accurate to the best of my knowledge.

DR. ROGER HASTINGS, Ph.D.

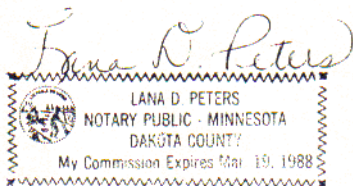

Chapter 7

ADDITIONAL AFFIDAVITS

Also attached is a copy of an Affidavit signed by Mr. Michael Meatyard, electrical engineer with the U.S. Army Corps of Engineers.

Additional signed Affidavits as well as television news endorsements have been provided by more than 30 competent individuals including myself. These Affidavits include physicists, a nuclear engineer, electrical engineers, aeronautical engineers, chemists, mechanical engineers, electronic/technical individuals, and others. These individuals are listed below, and these individuals should be complimented for their courage, since they were well aware of the significance of the impact of what they were saying.

Mr. Meatyard's Affidavit follows below with the names of the above-mentioned individuals who have tested and testified that the energy output from my system is greater than the external energy input into my system.

ENDORSERS OF JOE NEWMAN'S DEVICE

Jerry A. Miller
16675 Spruce Circle
Fountain Valley, California 92708
Profession: Electrical Engineer

Joseph Richard Trinko, Ph.D.
4635 Dryades Street
New Orleans, Louisiana 70115
Profession: Nuclear Engineer

Bobby Matherne
5901 Marcie Street
Metairie, Louisiana 70003
Profession: Physicist

John P. Gillis
4509 Tartan Drive
Metairie, Louisiana 70003
Profession: Dentist (physics background)

Eric J. Szuter
2301 Edenborn #807
Metairie, Louisiana 70001
Profession: Mechanical Engineer

Evan R. Soule', Jr.
1135 Jackson Avenue, #305
New Orleans, Louisiana 70130
Profession: Educational Contractor (physics background)

Henry T. Dart
3636 Jena Street
New Orleans, Louisiana
Profession: Attorney (physics background)

Marc Kahgan
5014 South Prieur Street
New Orleans, Louisiana 70125
Profession: Physician (physics background)
Director of Electronic Company

Douglas R. Mapes
2544 Robert E. Lee Boulevard
Apartment 210
New Orleans, Louisiana 70124
Profession: Student (electronics background)

Leslie D. Jensen
14144 Woodland Ridge Avenue
Baton Rouge, Louisiana 70816
Profession: Chemical Engineer

Gary N. Krasnow
933-B Louisiana Avenue
New Orleans, Louisiana 70115
Profession: Architect (physics background)

Arnold R. Smythe, Jr.
234 Glendale Drive
Metairie, Louisiana 70001
Profession: Consulting Structural Engineer

James H. Wilson
1701 Beltline Highway
Mobile, Alabama 36609
Profession: Civil Engineer

Robert E. Melton
401 Firestone Drive, East
Mobile, Alabama 36601
Profession: Electrical Engineer

Roger Hastings, Ph.D.
1204 Circle Hyde Drive
Burnsville, Minnesota 55337
Profession: Physicist

Thad M. Lee
3450 Armour Drive
Mobile, Alabama 36609
Profession: Electronics Technician

Patricia Wright
3450 Armour Drive
Mobile, Alabama 36609
Profession: Electronics Technician

Wayne Powell
3450 Armour Drive
Mobile, Alabama 36609
Profession: Electronics Technician

C. Emmett Pugh
1250 Poydras Street, Suite 2200
New Orleans, Louisiana 70112
Profession: Patent Attorney/Engineer

Gregory Upchurch
611 Olene Street
St. Louis, Missouri 63101
Profession: Patent Attorney/Electrical Engineer

Milton K. Everett
Mississippi State Department of Energy
and Transportation
510 George Street
Jackson, Mississippi 39202
Profession: Mechanical Engineer

Michael H. Meatyard
4703 Princeton Drive
Mobile, Alabama 36609
Profession: Electrical Engineer

Richard Vialton
Education: M.S., M.I.T., Electrical Engineering
Profession: Engineer with major manufacturer
of oscilloscopes

Lawrence C. Gibbs
5736 Citrus Blvd.
Harahan, Louisiana 70123
Profession: Building Engineer

Mansur Nathoo, Ph.D.
4 Little Stream Close
Northwood, Middlesex, England
Profession: Solid State Physicist

Thomas J. Herold
12117 Comanche Trail
Huntsville, Alabama 36803
Profession: Ph.D. Business Administration

Eike J.W. Mueller
NASA/MSFC
Code JA11
Marshall Space Flight Center, Alabama 35812
Profession: Aero-Space Engineer

Joseph E. Bolger
1404 Alegria
Austin, Texas 78757
Profession: Nuclear Engineer

Ralph Hartwell
WWL T.V.
New Orleans, Louisiana
Profession: Electrical Engineer

Ted Saari, Jr.
WWL T.V.
New Orleans, Louisiana
Profession: Electrical Engineer

Mort Zimmerman
High Tech Company
Dallas, Texas
Profession: Electrical Engineer

AFFIDAVIT

My name is Michael H. Meatyard. My address is 4703 Princeton Drive, Mobile, Alabama and my telephone number is (205) 342-1160.

I have personal knowledge of the following facts:

1. EDUCATION: My education includes a Bachelor of Science in Electrical Engineering (B.S.E.E.), 1971, University of South of Alabama, Mobile, Alabama.

Pertinent courses include the following:

Engineering Materials (Strength of Materials):

Calculus and Analytical Geometry;

Circuit Analysis;

Electronics and Communication;

Technical Physics (Classical);

Modern Physics (Relativistic);

Thermodynamics;

Statics;

Dynamics;

Heat Transfer;

Energy Conversion and Transmission;

Electromagnetic Field Theory.

2. WORK EXPERIENCE: My experience includes:

September 1967-January 1980

Alabama Power Company, Mobile, Alabama.

My duties included inspection of transmission lines; maintenance and operation of power distribution substations and equipment; design, inspection and maintenance of overhead and underground power distribution systems and equipment; and sale of electric energy and power.

January 1980-present

U. S. Army Corp of Engineers, Mobile, Alabama.

My duties include design of electrical distribution systems for military projects.

EXHIBIT F

3. GENERAL TEST PROCEDURE: The device shown in Exhibit 1 was tested. The input and output of the device was tested simultaneously. There were no conventional sources of energy input into the system other than a battery pack. See the attached sketches of input and output arrangements and list of equipment used.

4. EQUIPMENT USED:

A. Oscilloscope - Tektronix Model 2215.

B. Ammeter - Beckman digital multimeter Model TECH 310.

C. Battery pack - 24-6Volt nominal (average voltage 6.25).
Ray-O-Vac Model 945.

D. Pulley - radius equal 2-1/2"; constructed of aluminium alloy.

E. Weight - approximately 1.3 oz. lead.

F. Precision one ohm resistor - Model CMF-60 metal film
manufactured by Dale Electronics, Inc.

G. RPM Determination - time determined with Micronta, LDC
Quartz Chronograph, Model 63-5009.

H. Voltmeter - Simpson Model 260.

5. INPUT: The dual trace oscilloscope was used to monitor voltage and current into the device (See Exhibit 2, 3, and 4). Also, the Beckman ammeter was used to monitor current simultaneously with the oscilloscope (See Exhibit 2).

A graph of power versus time was constructed using voltage and current values from the oscillograph. This was done over the length of one complete electrical cycle, using current values no greater than those shown on the oscilloscope graph (0.4 AMP most negative value) which is conservative. A graphical integration of the power versus time graph was then done to obtain the energy input during the cycle. This energy was then divided by the length of the cycle in seconds to yield average input power (See Exhibit 5).

$$\begin{aligned} \text{Average input power} &= \frac{0.93 \text{ joules} - 3.6 \text{ joules}}{0.37 \text{ seconds/cycle}} \\ &= -7.216 \text{ watts (Negative)} \end{aligned}$$

The Beckman ammeter readings were also taken throughout the experiment and it was observed that negative values of current occurred frequently. Actual values of current observed on the ammeter were not recorded since it is felt that the oscilloscope is a much more accurate instrument for recording and measuring the input current. However, the visual observations made on the ammeter clearly substantiate the findings that the oscilloscope produced. For example, the enclosed photo (Exhibit 6) shows a value of -5.77 amps being displayed on the ammeter. This photo was taken during the experiment.

6. OUTPUT: Mechanical output power was measured by using a prony break arrangement (Exhibit 7 and 8). A known weight was used to apply a force to a torque arm of radius "R". The RPM was measured by using a digital stopwatch and simply counting the revolutions of the device in a given interval of time. Output was determined by use of the following equation.

$$\text{Horsepower (HP)} = \frac{2\pi}{33,000} \times F \times R \times N$$

Where,

F = Force in pounds

R = Radius of torque arm in feet

N = Revolutions per minute.

Date Gathered:

F = 1.3 oz. = 0.081 lbs.

R = 2-1/2" = 0.2083 feet

N = 162 RPM

Calculation:

$$\text{HP} = \frac{2\pi}{33,000} \times 0.081 \times 0.2083 \times 162$$

Horsepower = 0.00052

1 horsepower = 746 watts, therefore,

Output watts = 0.00052 x 746 = 0.38 watts

The output of this device is not due to inertia because it operated several minutes prior to testing and it was observed that it stopped in less than 15 seconds when disconnected from its power supply with the mechanical load in place.

7. OPINION: In my opinion, based on my education, experience, and the tests described herein, Mr. Newman's device

A. has greater output power than input power, and accordingly,

B. does, indeed, have greater energy output than external energy input.

This opinion is my own and is in no way represented to be that of my employer.

MICHAEL H. MEATYARD

Sworn to and subscribed before me on this 9th day of November, 1983.



NOTARY PUBLIC,



EXHIBIT 1

INPUT ELECTRICAL ARRANGEMENT

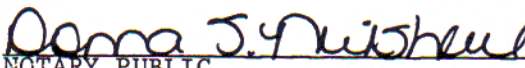
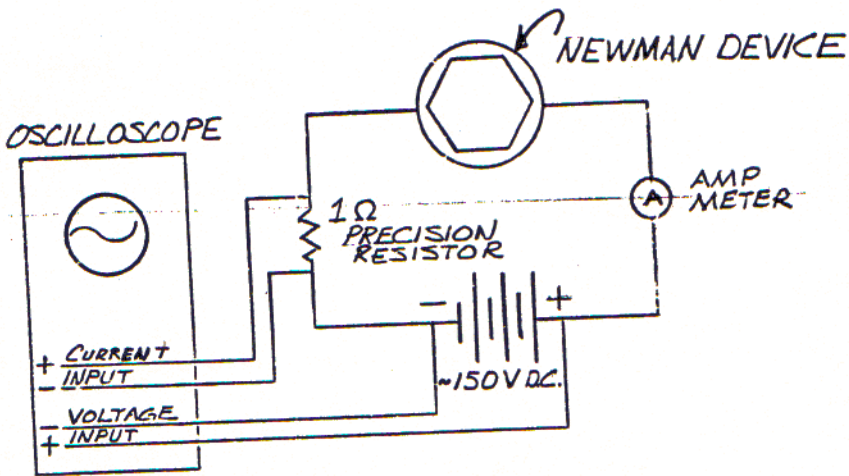
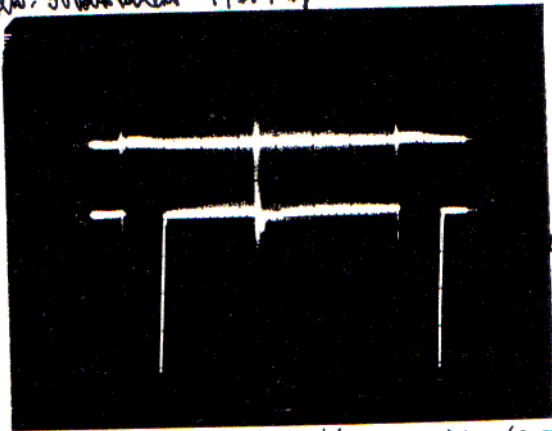

EXHIBIT 2

Volts: 50 Volts per Cent 14th May



Current = .1 Amp per Cent Sweep time: \approx 50 NS / Cent

EXHIBIT 3

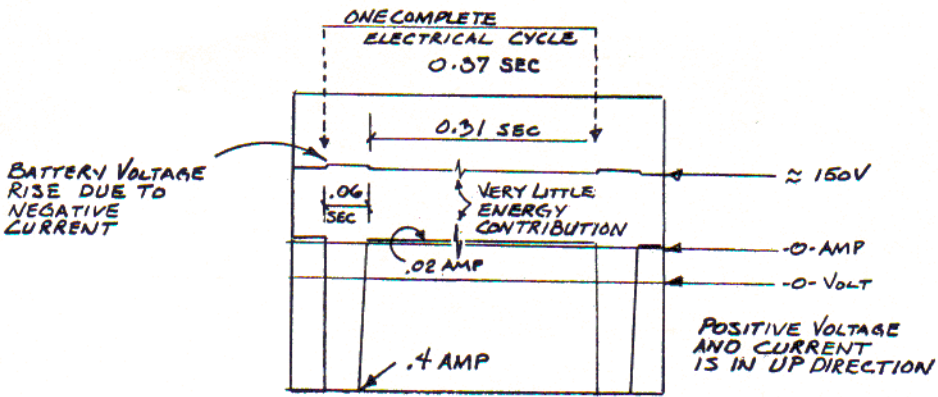
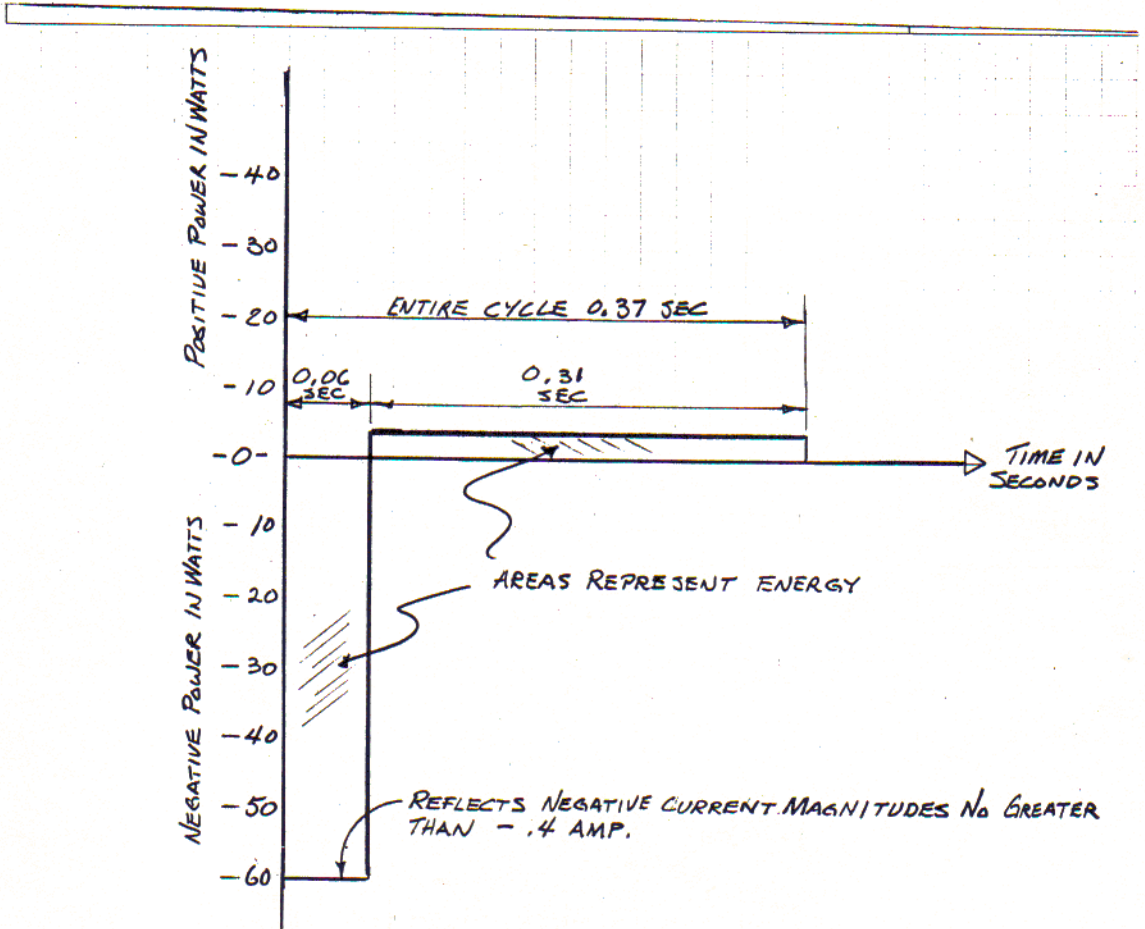

EXHIBIT 4

RECONSTRUCTION OF EXHIBIT 3



POWER IN WATTS AS A FUNCTION OF TIME

ONE CYCLE

EXHIBIT 5

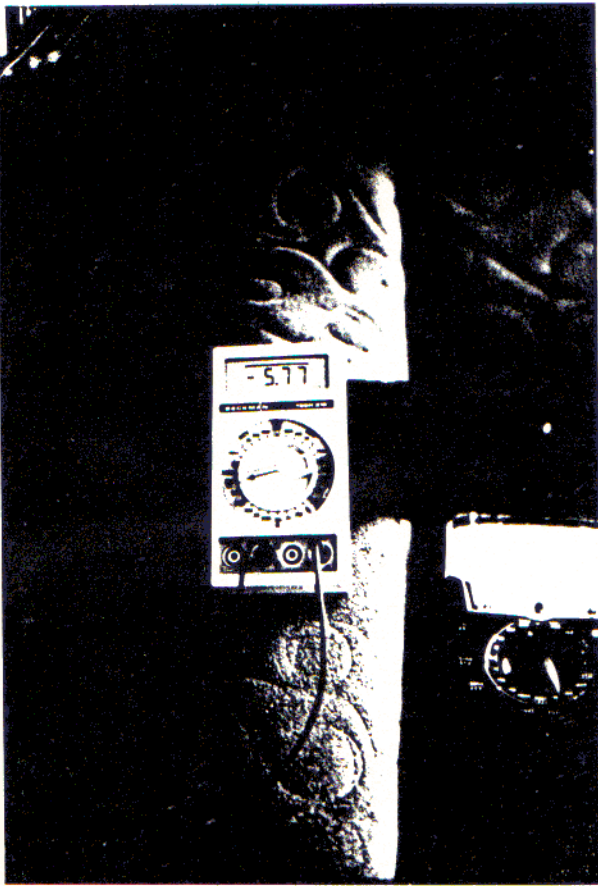

EXHIBIT 6

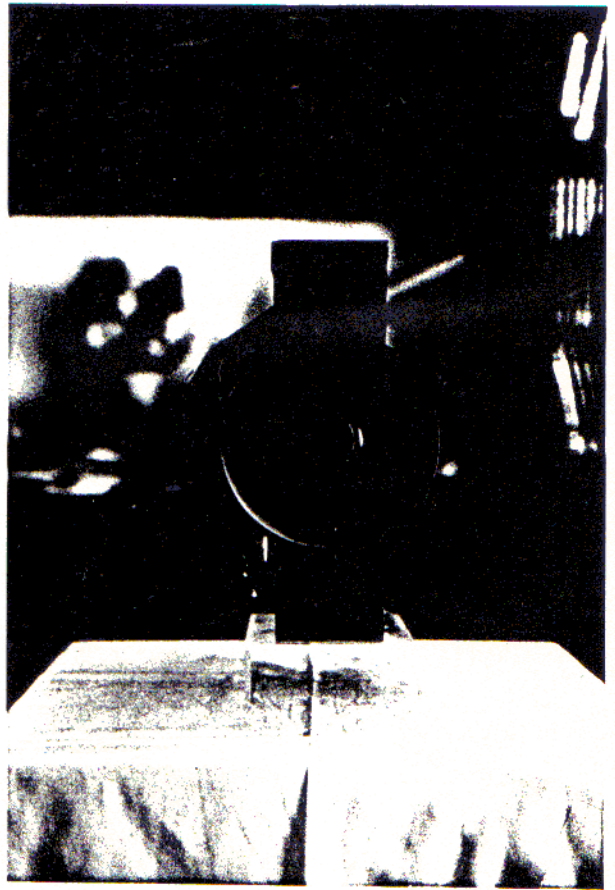

EXHIBIT 7

OUTPUT PHYSICAL ARRANGEMENT

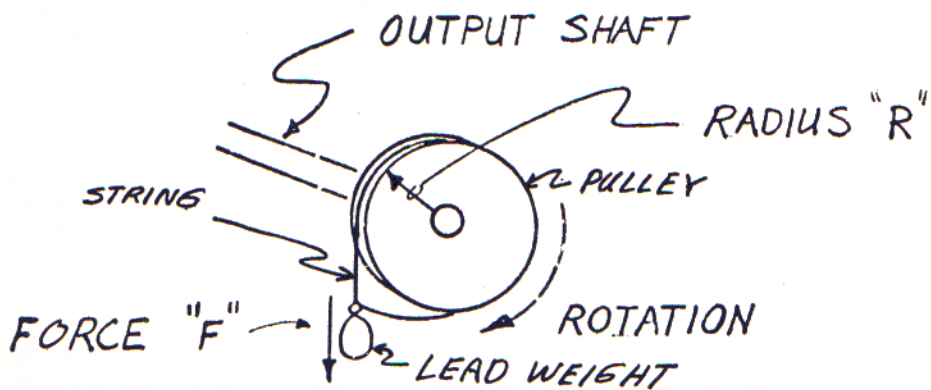

EXHIBIT 8

Chapter 8

ANALOGIES USEFUL

IN UNDERSTANDING

THE TECHNICAL SYSTEM

"A new scientific truth does not triumph by convincing its opponents and making them see the light, but rather because its opponents eventually die, and a new generation grows up that is familiar with it."

— Max Planck

I will now discuss in greater detail "how" and "why" my conducting-coil-unit operates.

16. Let us study another analogy (see 16-A and 16-B below):

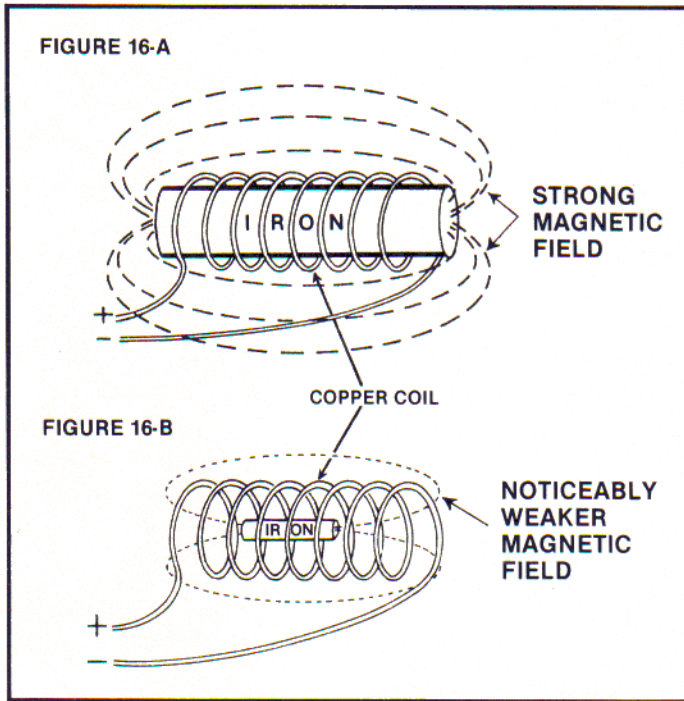

If 1 amp of current goes into Figure 16-A, a noticeably larger magnetic field occurs than in Figure 16-B (for the same current input).

QUESTION: Why the large difference in the strength of the magnetic field?

ANSWER: Simple. We have already demonstrated that the iron becomes magnetic due to atom alignment. Therefore, via the small electrical input acting as a catalyst, we have simply caused more atoms to align in the larger mass of iron in Figure 16-A above than in the smaller mass of iron in Figure 16-B.

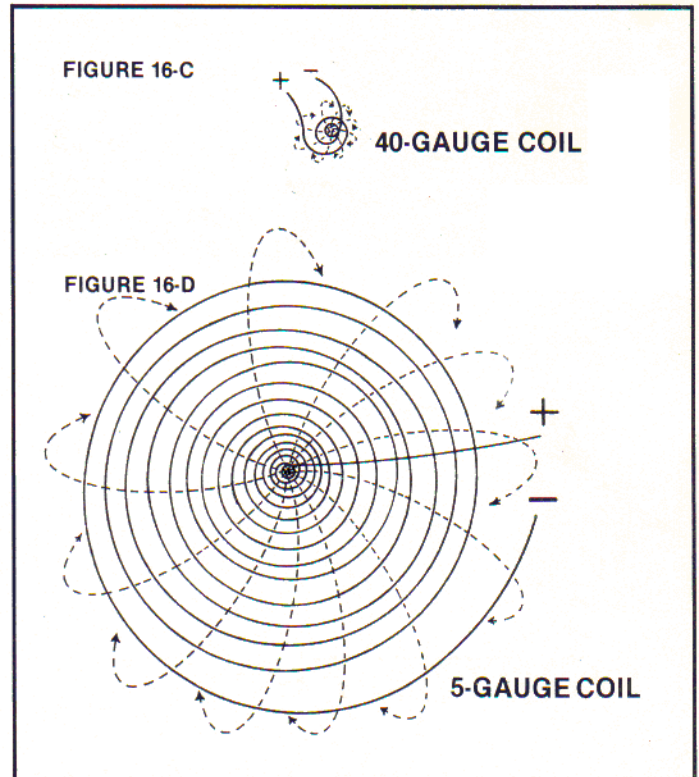

If 1 amp of current goes into Figure 16-C, a noticeably smaller and weaker magnetic field occurs than in Figure 16-D.

QUESTION: Why the difference?

ANSWER: Simple. As we have already proven, we have more copper atoms to align in coil 16-D than in coil 16-C.

16

E. All of the facts presented in Sections 1-16 clearly prove that the current (consisting of gyroscopic particles in motion) put into a conductor simply acts as a catalyst in aligning the atoms of the conductor itself. This same catalytic effect is observed if a conductor is

wrapped around iron and the current runs through the conductor. In other words, the current simply acts as a "pure catalyst!" The current input triggers the atom alignment which results in energy (gyroscopic particles) being released from the atoms aligned. However, the electrical current input does *not* participate in the magnetic field released.

¹⁶
F. There is another important mechanical effect of the gyroscopic particles comprising a magnetic field, electric field, and all matter, which I refer to as a "Hydraulic Effect." (See Figure 16-F1.)

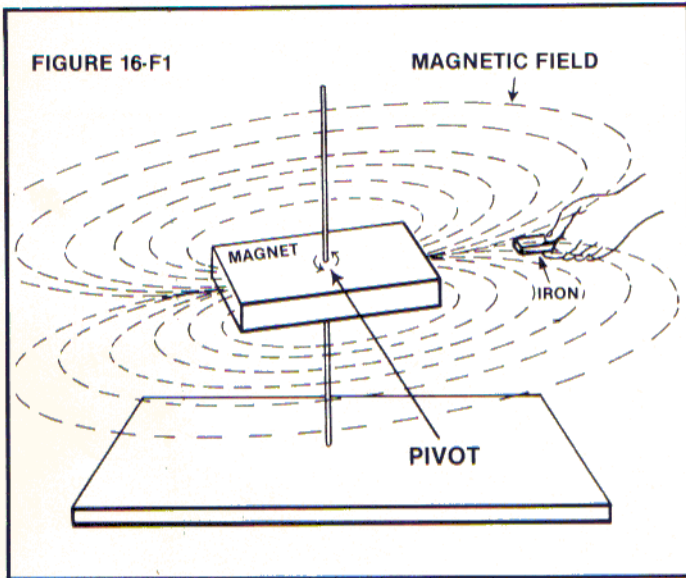

If one places a piece of iron in a magnetic field and the source (magnet) is fixed to a pivot (see Figure 16-F1 above), then, if the piece of iron is moved, the magnet will also attempt to move. It is mechanically obvious that there is a magnetic "coupling effect" generated by flowing "streams or shells" of gyroscopic particles comprising the magnetic field and originating from the atoms of the magnet. I originally asked myself: "How else could there be an action-reaction effect?" Any motion whatsoever on the part of the piece of iron will cause an attempted motion of the magnet itself. This action is the same type of effect as found in a hydraulic system. (See Figure 16-F2.)

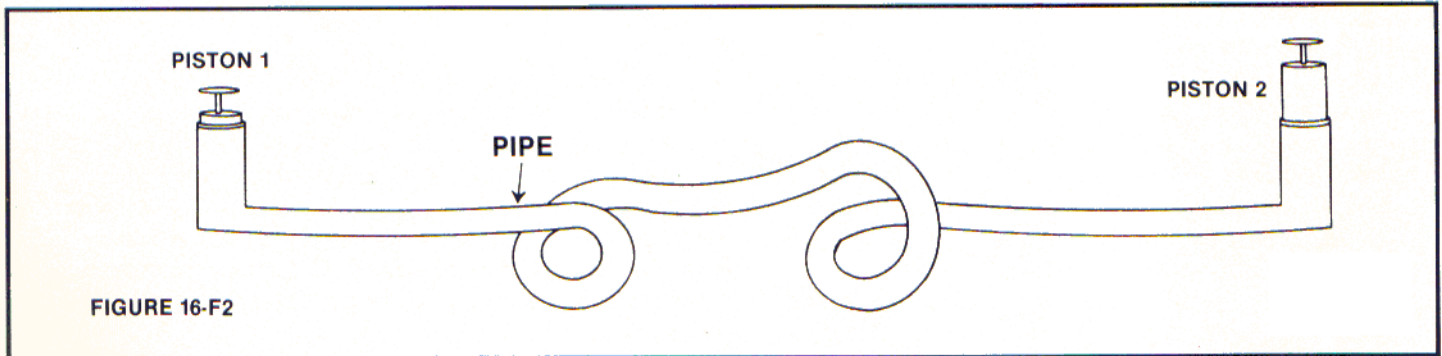

If the pipe is filled with fluid and the piston is moved, then piston 2 will also move. If the pipe is filled with a gas and piston 1 is moved, then piston 2

will also attempt to move. However, enough pressure can be imposed on piston 2, causing the gas molecules to compress into a smaller area within the pipe. *The same effect can be found in magnetics.*

¹⁶
G. The same type of hydraulic effect can be observed in the electric current (gyroscopic particles) coming from a battery or generator and flowing into a conductor to align the atoms within the conductor. The atoms of the conductor are aligned due to the pres-

"The current input triggers the atom alignment which results in energy (gyroscopic particles) released from the atoms aligned. However, the electrical current input does not participate in the magnetic field released."

sure of the voltage from the battery or generator. The current (gyroscopic particles) that is derived from the atoms of the material within the battery or the atoms within the conductor and magnet of the generator is the energy which comprises the atoms of the material from which the current (gyroscopic particles) originates. The gyroscopic particles actually create a hydraulic effect back to the atoms from which the gyroscopic particles come. This action is mechanically similar to any hydraulic pumping system.

¹⁶
H. There is a most important distinction, however, between the power source of conventional hydraulic systems and that which I have discovered and developed. The current (gyroscopic particles) which comes from a battery or generator is the energy which comprises the atoms of the materials from which current (gyroscopic particles) comes. This action is literally the mechanical essence of Einstein's Equation $E = MC^2$.

Therefore, a battery connected to the proper output system will be destroyed in accordance with $E = MC^2$! I am not referring to the present, inefficient chemical reaction within a battery, since present teachings state that all energy-producing devices (which use current) operate via the current input only. This is not true!

Such present teachings have resulted in designs for inefficient battery devices which are deliberately constructed to use relatively high current. I teach the

opposite. One should build devices to use *as little current as possible and practical* in order to restrict that current from completing the circuit and returning to the battery or generator.

EXAMPLE: Let's examine a typical battery — an electrochemical cell. These devices operate according to Faraday's Laws. Faraday's First Law states that the quantity of electricity that passes through a solution is proportional to the quantity of substance decomposed. You will note that this action is solely dependent upon the current (gyroscopic particles) completing the circuit. If the current (gyroscopic particles) does *not* complete the circuit, *there will be no quantity of substance decomposed.* (See Figures 16-H1 and 16-H2.)

duction effect would have far greater power than that which originally came from battery 16-H1 on a chemical basis only. If you, the reader, have now mastered what I have taught, you will quickly recognize that the action-reaction effect within coil 16-H2 and the hydraulic effect of battery 16-H1 all operate in accordance with $E = MC^2$.

“One should build devices to use as little current as possible and practical ...”

In effect, the current (consisting of flowing, gyroscopic particles) coming from the atoms of coil 16-H2 and battery 16-H1 are *the mechanical essence of $E = MC^2$* and, consequently, the mass of the entire system will be re-

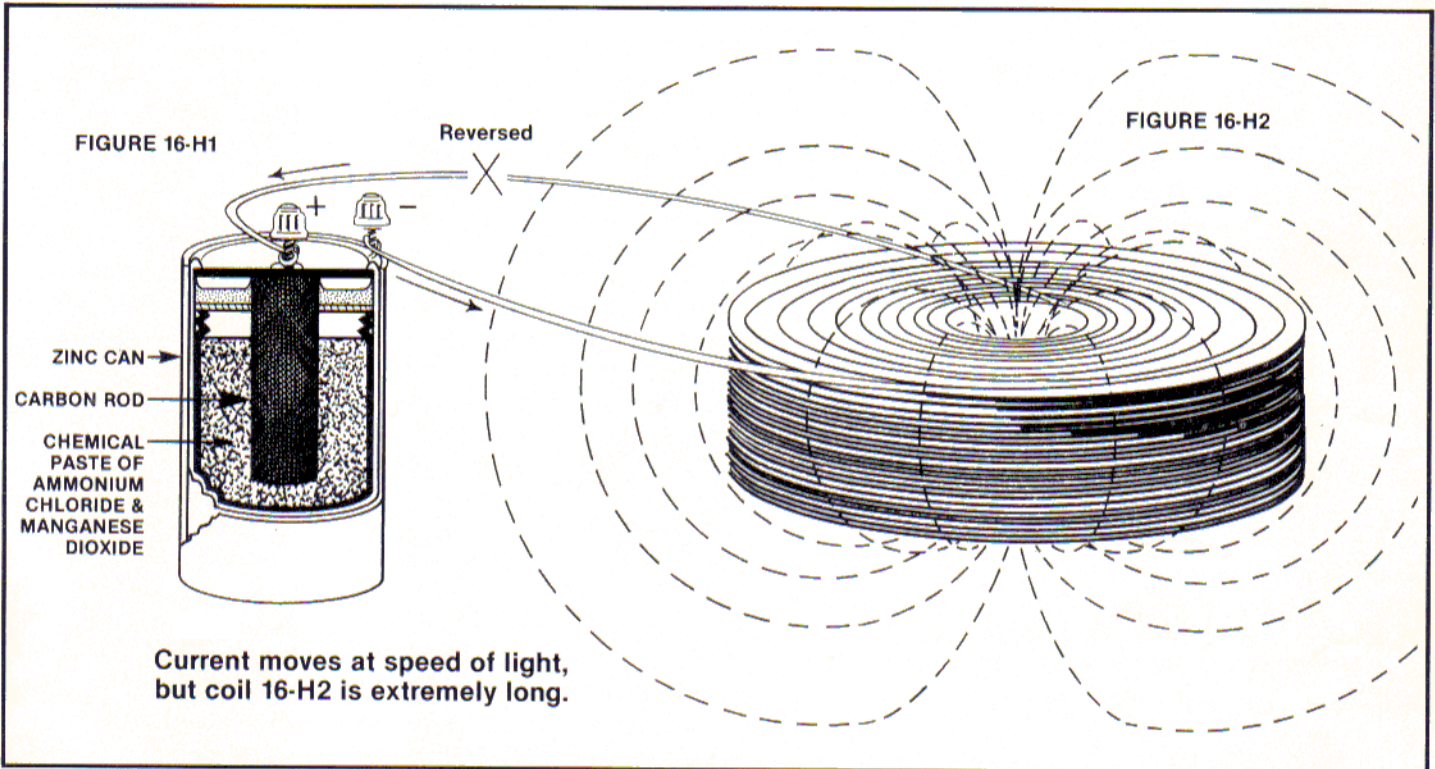

Re-examine the coil in Figure 15-B and then compare it to that in 16-H1 and 16-H2 above. Envision that if coil 16-H2 is composed of 5-gauge copper wire with such a length that its resistance is 1,000,000 ohms and the battery voltage of 16-H1 is 1000 volts, then only 1 milliamp of current could flow through coil 16-H2 and complete the circuit to return to battery 16-H1. It is obvious that the energy within the magnetic field of coil 16-H2 would be tremendous, and, if the direction of the current was reversed by a commutator (or similar mechanism) at position (X) above, *before* the current of 1 M.A. passed through the coil, then *no decomposition of the battery by chemical means would occur.* However, the *hydraulic effect* of the 1000 volts from battery 16-H1 would have already affected (catalytic effect) and aligned many atoms within coil 16-H2. Such alignment would generate a tremendous magnetic field (gyroscopic particles). When the current was reversed within coil 16-H2 by the pressure of 1000 volts from battery 16-H1, the in-

duced via $E = MC^2$ as energy is removed from the system. However, due to the high *conversion efficiency* within the process, it would actually require an extremely long period of time — measured in years — to significantly deplete the mass of the materials involved in the system.

It should be obvious to you that the electric current (gyroscopic particles) which emanates from the elements of battery 16-H1 is not depleted in coil 16-H2. If permitted, not only would the battery input current align the atoms of coil 16-H2, but once the current returns to the battery, such current would, according to Faraday's First Law, chemically decompose large quantities of matter compared to the minute size of the current (in the form of gyroscopic particles) which activates the undesirable chemical reaction.

These gyroscopic particles obey the First Law of Thermodynamics precisely: ***it appears they cannot be destroyed and it appears they possess a motion of infinite duration.***

17. You, the reader, must now obtain the proper perspective within your mind. (See Figures 17-A and 17-B.)

an electrolytic basis. Rather, what occurs is action according to $E = MC^2$ via the efficient conversion of *magnetic mass* (gyroscopic particles traveling

FIGURE 17-A

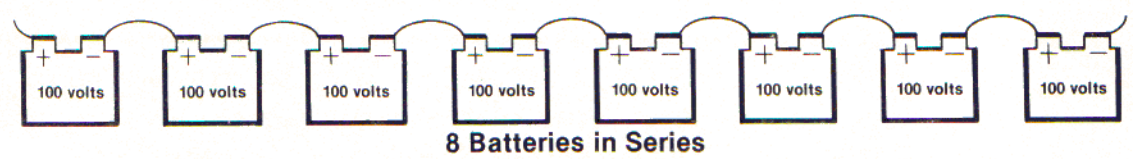
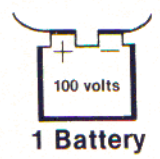

FIGURE 17-B

What distinction do you instantly detect between Figures 17-A and 17-B? You should recognize that one obtains greater energy from 17-B than from 17-A. You should recognize this fact on a chemical basis. However, you should also see that this distinction between Figures 17-A and 17-B can also be visualized according to $E = MC^2$ if properly understood and utilized.

Now examine Figures 17-C and 17-D:

throughout the space surrounding aligned atoms — also referred to as “magnetic energy”) to *electrical energy* (gyroscopic particles traveling through a conductor)*. If the technical system is properly utilized, one should not be surprised that an energy output can be achieved which is in excess of the external energy input. Consequently, one should instantly recognize that one can obtain greater energy from coil 17-D than from coil 17-C.

FIGURE 17-C



.01 lb. of 40-gauge copper wire

FIGURE 17-D

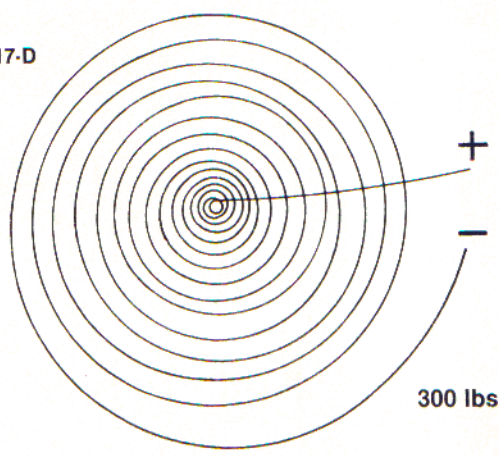

300 lbs. of 40-gauge copper wire

What difference do you recognize between Figures 17-C and 17-D? You should immediately recognize that there are 30,000 times *more* atoms in Figure 17-D than in 17-C. And you should also recognize that these atoms are — in effect — extremely small batteries (see Figures 17-A and 17-B above), except that there is *no* chemical reaction on

* *Note:* referring to energy as “electrical” or “magnetic” without understanding the essential nature of such energy can be conceptually misleading. There exists only *one* (mechanical) concept of energy: *gyroscopic particles in motion*. This single concept of energy can be observationally manifested in different forms: when traveling through a conductor (metal wire), the gyroscopic particles are commonly called “electrical” energy. When traveling throughout the space surrounding aligned atoms, the same gyroscopic particles are perceived as “magnetic” energy.

If one calculates the resistance in Figure 17-D compared to that of Figure 17-C, one finds the resistance of 17-D to be approximately 30,000 times the resistance of 17-C. Note that this fact coincides with my previous statement that the conducting coil 17-D contains 30,000 times more atoms than conducting coil 17-C.

However, to greatly increase the desired results, return to tests 15-A and 15-B. You will find in those tests that the resistance in 15-B is equal to that of 15-A, but within the coils of these two tests the number of atoms in each vary greatly. This difference is due to the fact that conducting coil 15-B has a phenomenal 110,704,968 times more atoms than conducting coil 15-A.

What is significant in Figure 18-A is the fact that when the small cylinder of niobium-tin alloy is removed from the liquid helium, the alloy instantly loses its formidable, magnetic field.

The reader should quickly recognize that in test 18-A, the niobium-tin alloy initially possessed energy (heat) which was removed from its mass when placed in liquid helium. This heat loss instantly results in a large reduction of the random atom motion within the alloy and therefore a high percentage of the alloy's atoms then align to release some of their electromagnetic energy (gyroscopic particles) throughout the formidable, magnetic field created.

You can easily see that this cryogenic process is op-

“... for a given current input ... the most efficient conducting system design is one in which the greatest number of atoms within a coil are aligned by the given current (gyroscopic particle) input.”

18. *At this point, it should be clear that for a given current input (consisting of gyroscopic particles) from a battery, generator, etc., the most efficient conducting system design is one in which the greatest number of atoms within a coil are aligned by the given current (gyroscopic particle) input.*

It is therefore obvious that a properly designed, super-conducting system would produce even greater results. As of this writing, work is being performed by other scientists in an attempt to develop a super-conducting material which can operate at temperatures higher than those previously developed.

A. Let us examine super-conducting magnets in view of what I teach. In Figure 18-A, when a small, fist-sized cylinder of niobium-tin alloy is placed in a flask of liquid helium having little or no current input, the cylinder becomes a formidable magnet of 24,000 gauss. Additional materials have been developed that are capable of producing superior results.

posite to the Curie temperature effect of heat input (energy) into a permanent magnet resulting in atom unalignment, i.e., increased random atom motion, and virtual disappearance of the magnet's field. (See Figure 12-D2 on page 9 for comparison.)

If the small, cylindrical, niobium-tin alloy is removed from the liquid helium, then heat (energy) travels into its mass from the environment which results in a significant increase in the random motion of the atoms within its mass. *This action creates the disappearance of the magnet's prior magnetic field since the gyroscopic particles which previously composed the magnetic field have now returned into the original atoms from which they came.* [These results scientifically match those of test 12-D above.]

“... I stress that it is essential that one design and establish the correct geometric configuration.”

19. *For optimal results, I stress that it is essential that one design and establish the correct geometric configuration! With such a correct configuration, the atoms of the substances involved will intersect the gyroscopic particles (composing the magnetic field of the system) at the proper angle. In some designs it may be desirable that those atoms within the system do not (or minimally) intersect the gyroscopic particles, i.e., in such instances, only gyroscopic particles should mechanically interact with one another.*

“One must pay strict attention to the mechanical essence of the gyroscopic action of these particles ...”

One must pay strict attention to the mechanical essence of the gyroscopic action of these particles

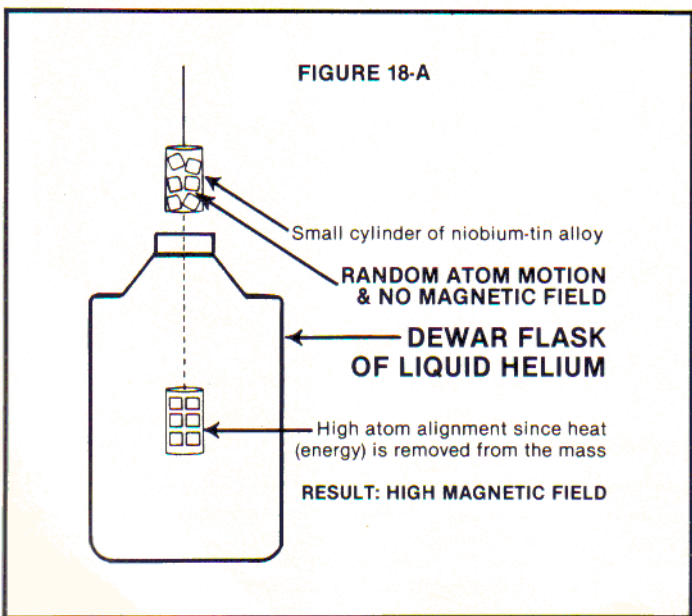

moving in a magnetic field and emanating from the atoms of the substances involved in the process. Such gyroscopic particles are the mechanical essence of the equation $E = MC^2$. (See Figure 19-A.)

FIGURE 19-A

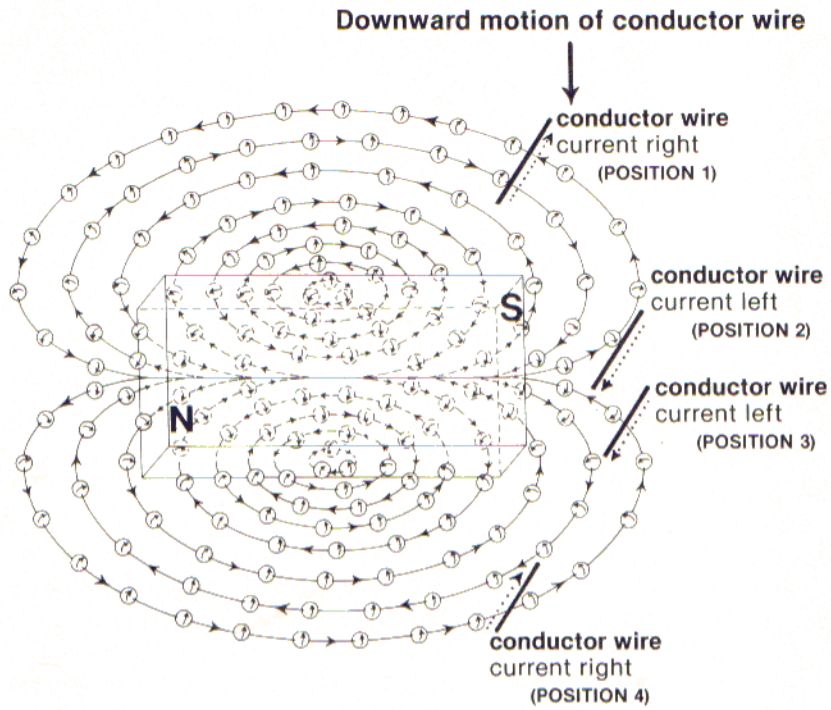

When a conductor is physically moved down and across a magnetic field as in Figure 19-A, then the current will change direction *twice*. The same is true if the conductor is moved from the South end of a magnet to the North end of the magnet. *Reason:* the direction of gyroscopic action is changing throughout the "lines (shells) of force." However, if a small, multi-looped, 38-gauge conducting-coil-wire [approximately 11/32-inch in diameter and 3/4-inch long] is moved across the end of a 6-inch diameter magnet, the current direction will alter *four* times. (See Figure 19-B.)

FIGURE 19-B

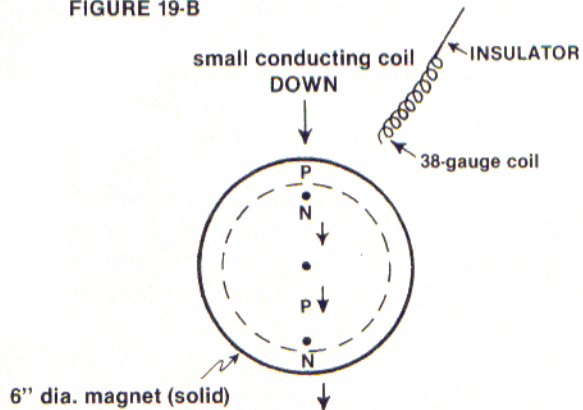
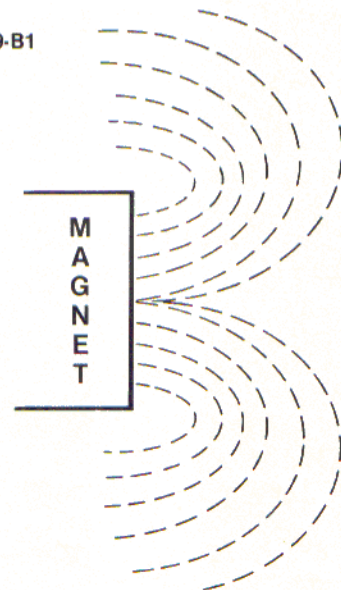

FIGURE 19-B1



By moving the 38-gauge, copper-wire coil across the end of the magnet (as shown in Figure 19-B), the current direction will now change *four times*. [P = positive and N = negative.] It is extremely important to recognize that the “lines (shells) of force” (gyroscopic particles) continuously vary in their exact direction at any given moment. Study Figure 19-B1 above and observe that the angular direction of the “lines (shells) of force” (gyroscopic particles) vary from the center of the magnet to the *left*, in one plane of the magnetic field, and to the *right*, in the opposite side of that same plane.

Also observe that at the points marked with a dot (•) in Figure 19-B above, there is no current produced even though the moving, small coil is never parallel with the “lines (shells) of force.” Reason: This occurs as a result of a *cancellation effect*, *i.e.*, one side of the small coil is located within one plane of gyroscopic particles possessing a given angular direction, while the opposite side of the small coil will be located in another plane of gyroscopic particles possessing a different angular direction. The identical effect will be observed if the small coil is moved from the North to the South end of the magnet.

The reader should understand that I did not observe the above results by accident. On the contrary. I utilized the small diameter coil because I expected that it would more effectively detect the varying angles of the gyroscopic particles involved. The results I obtained totally corroborated my expectations. It should now be obvious to you that relative to a magnetic field, the angular directions of the gyroscopic particles are of extreme importance with respect to a substance’s given geometric design.

I would anticipate that computer technology — which is pictorially capable of depicting the mechanical essence of the action/reaction, gyroscopic effect of energies — would be very helpful in predicting more efficient designs and in computing useful mathematical formulas.

What should *not* be done is for one to simply “throw together” some design concept and then place it in a magnetic field without giving careful consideration to the mechanical essence of the energy of that magnetic field, *i.e.*, the mechanical essence of the energy (in the form of gyroscopic particles) comprising the atoms of the substance or substances of the design. Prior to my work, a lack of mechanical thought has been the norm, and, as the reader is well aware, the progress of science and the human race has suffered.

I stress to you, the reader, that there are *many* designs which will effectively release the energy in a magnetic field in accordance with the conversion of the mass from which the magnetic field emanates via $E = MC^2$.

The electromagnetic composition of the atoms of materials which initiates an input current flow is constant, is similar to hydraulic pressure, and appears to **move** at the speed of light. In addition, such input current behaves *solely* as a *catalyst* in interacting with the electromagnetic nature of the atoms comprising other

materials and caused such atoms to release a portion of their electromagnetic energy in the form of a magnetic field composed of gyroscopic particles. Such action increases the capacity of the system for performing “Obvious” or “Unobvious” Work, Force, or Power. The system can then react with another magnetic force or the atoms (gyroscopic particles) of that source to multiply this electromagnetic effect even further.

20. Let’s examine the facts which corroborate the previous statement:

20

A. I have already proven that the greater the number of atoms aligned within a magnet, the greater the release of the magnet’s energy (gyroscopic particles) in accordance with the equation $E = MC^2$. (See Figures 20-A1, 20-A2, and 20-A3.)

FIGURE 20-A1



No Magnetic Field

FIGURE 20-A2

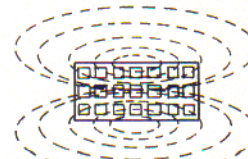

Magnetic Field

FIGURE 20-A3

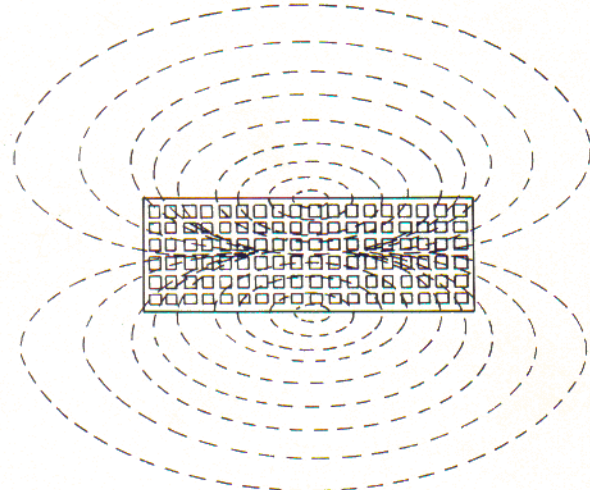

HAS A MUCH STRONGER AND LARGER MAGNETIC FIELD